



TECHNICAL GUIDE
BEONSTONE PANELIZED STONE SIDING



TABLE OF CONTENTS

This installation guide provides detailed step-by-step instructions for do-it-yourself projects. We invite you to read it carefully and then keep it handy for reference. You can also view each step on the accompanying video. For additional information, visit our website at www.beonstone.com.

STEP 01 – MATERIAL

TOOLS REQUIRED.....04

MATERIAL.....05

MATERIAL REQUIRED.....06

STEP 02 – PREPARATION

WALL TYPES.....08

MARKING THE WALL.....08

CONDITION OF SURFACE.....08

STARTER STRIP.....09

STEP 03 – INSTALLATION

WALL WITH NO CORNERS.....10

WALL WITH AN EXTERIOR CORNER.....14

WALL WITH AN INTERIOR CORNER.....16

STEP 04 – ARCHITECTURAL DETAILS

SILL CAPS.....18

WINDOWS AND DOORS.....20

TRANSITIONS.....22

COLUMN / PROTRUDING WALL.....22

COMPLEMENTARY PRODUCTS.....23

CROSS-SECTIONS

TECHNICAL DRAWINGS.....24



INTRODUCTION

Discover the world of Beonstone! A world of distinctive products for creating or transforming a living space—in just a few hours!

Lend your home an incomparable touch of style and elegance with the natural look of Beonstone panelized stone siding.

This innovative product's unique design combines the refined appearance of stone with simple, efficient installation and unsurpassed performance. Stylish indoor and outdoor projects can be completed in a few short steps and offer the protection of an exclusive integrated drainage system.

Each model of Beonstone panelized stone siding comes in 18 different stamped forms that perfectly reproduce the random look of natural stone.

Beonstone brings a contemporary look to stone!

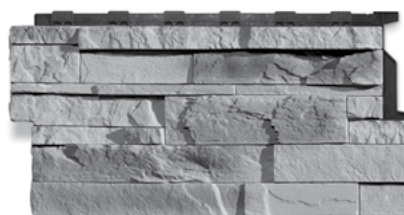

PATENTED **D.RAIN** SYSTEM

The D.RAIN system is built into the back of every panel. It automatically aligns, blocks and anchors the panel into the framing and ensures safe drainage in the event of water infiltration.

Mechanical anchoring system

Screw panels directly into the substrate.

- Panels attach firmly
- Maximum stability

Integrated colour

Panels are made from richly coloured concrete.

- Will not discolour
- Colour remains intact even if the panel is damaged

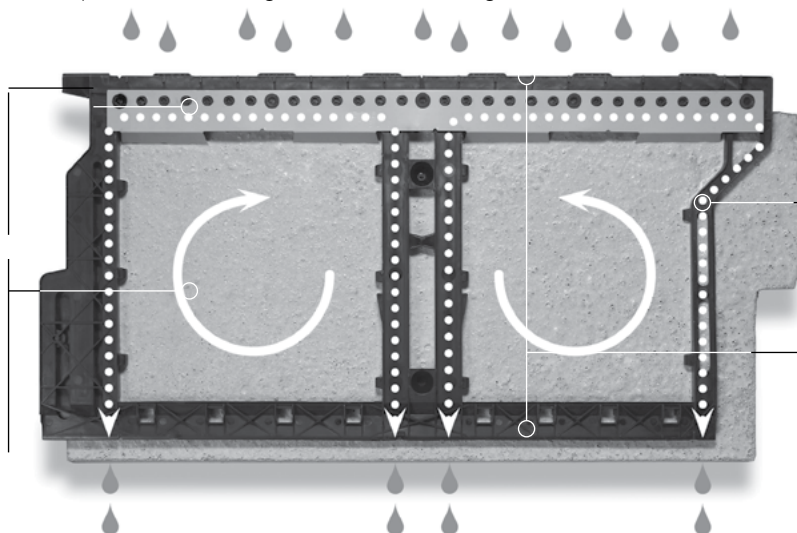

Drainage

Any water infiltration is automatically drained to the bottom of the wall.

- Prevents excess humidity and mildew
- An air space allows the wall to ventilate

Self-aligning and self-blocking system

Designed for quick installation and better alignment of panels over a large surface.

- Easy to install
- Structurally strong

STEP 1

TOOLS REQUIRED

Beonstone panelized stone siding are easy to install and require few tools. You probably have most of them already.

You will need a drill, screwdriver, table saw and concrete hand grinder, as well as a level, measuring tape and sheet metal cutters.

Be sure to wear appropriate safety equipment: safety boots, hard hat, safety goggles, mask, gloves and earplugs.

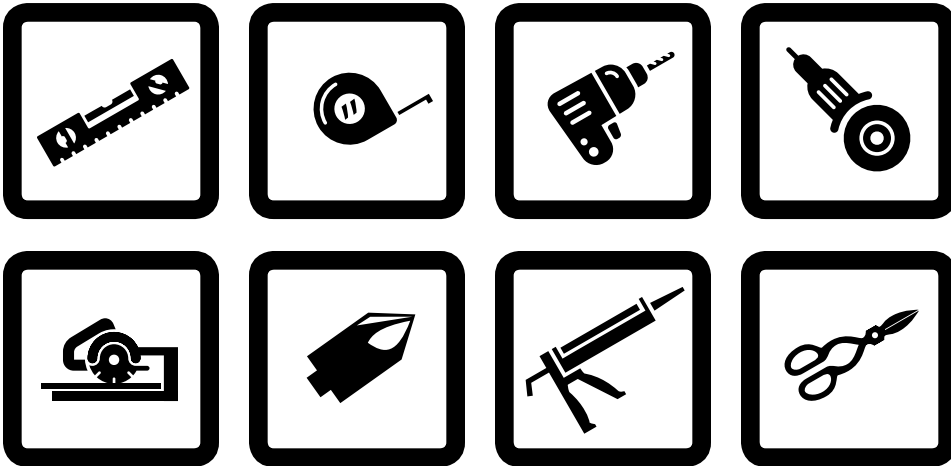

MATERIAL

The unique design of Beonstone

Beonstone offers a truly unique design. Some simple material is all you require to complete interior or exterior projects that are stylish and durable.

Take a few minutes to consider the material you need. Then choose Beonstone panelized stone siding products so you can complete your project like a professional.

Beonstone anticorrosive screw



Beonstone lighting fixture plate

254 mm x 200 mm x 51 mm (9.5 in. x 7.5 in. x 1.5 in.)



Beonstone electrical outlet plate

200 mm x 152 mm x 51 mm (8 in. x 6 in. x 1.5 in.)

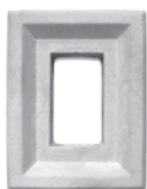

Beonstone cornerstone

254 mm x 191 mm - 165 mm x 64 mm (10 in. x 7.5 in. - 6.5 in. x 2.5 in.)

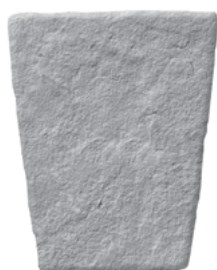

Beonstone panelized stone siding

610 mm x 305 mm x variable (24 in. x 12 in. x variable)

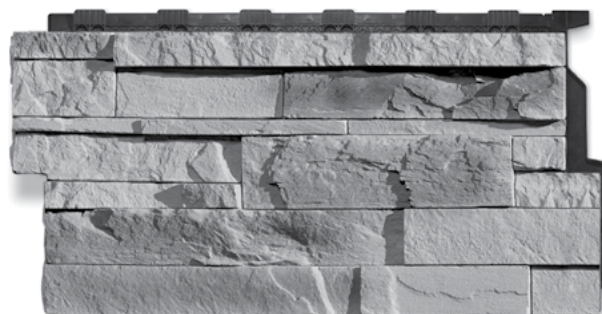

Beonstone starter strip

1220 mm x 48 mm (48 in. x 1 7/8 in.)

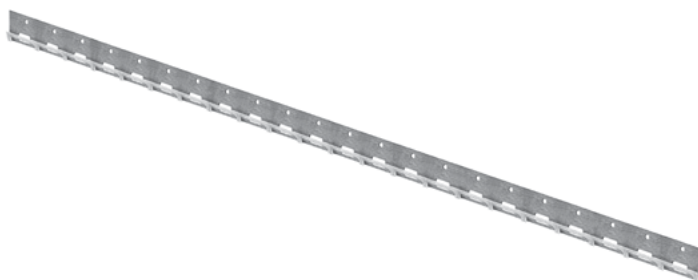

Beonstone transition sill cap

813 mm x 89 mm x 51 mm (32 in. x 3.5 in. x 2 in.)

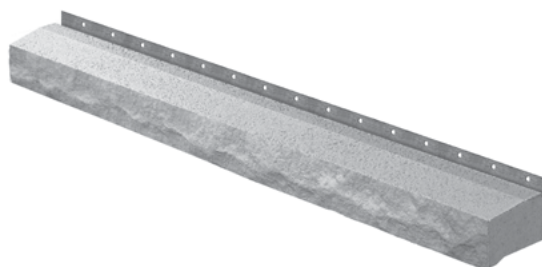

Beonstone window sill cap

813 mm x 89 mm x 51 mm (32 in. x 3.5 in. x 2 in.)

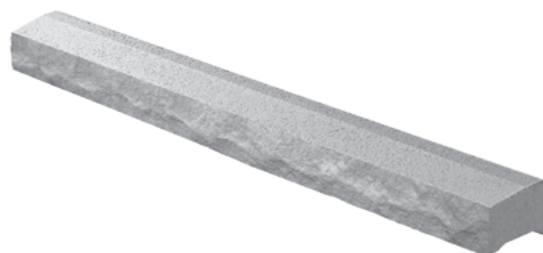

STEP 1

MATERIAL REQUIRED

1.1 Calculate the material required

Before starting your project, calculate the quantities of material you will need. Beonstone panelized stone siding are designed to fit in corners without any additional special material. **Simply measure the length (L) and multiply it by the height (H).**

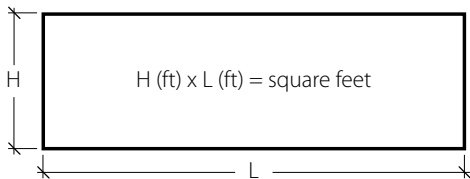

Beonstone panelized stone siding

To determine the number of panels required, calculate the surface area of the wall to be covered. Multiplying the length by the height (L x H) in feet gives you the total number of square feet. Divide this number by 2.

Example: **L** (16 ft.) x **H** (8 ft.) = 128 sq. ft. ÷ 2 = **64 panels**

This gives the number of panels required. It is recommended that you add an extra 3% for waste during installation.

Table to calculate the number of Beonstone panelized stone siding
(1 panel = 2 sq. ft.)



Measurements in feet

Table to calculate the number of starter strips
(1 strip = 4 li. ft.)



Measurements in feet

Your list of materials is ready to order

- Beonstone panelized stone siding
- Starter strips (order a few extra)
- Window sill caps
- Transition sill caps for partial walls
- Stainless steel screws (see the table)
- Tubes of sealant
- A 300-ml (10-oz) tube of PL Premium adhesive
- Elastomeric waterproofing membrane air/water
- Building cladding tape (Tuck Tape)

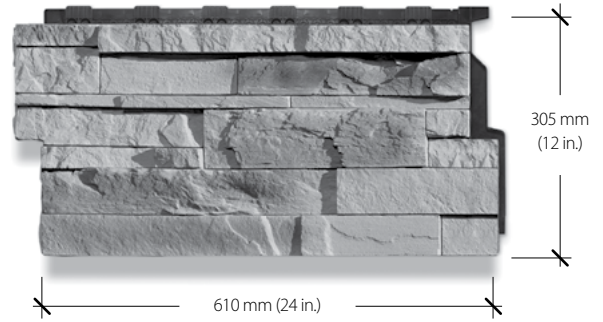

Calculate the number of units for a gable side wall

In the case of a gable, it is recommended to calculate the rectangular surface (A x B – illustration A) rather than the triangular surface. There will be a greater loss (Illustrations B and C).

Illustration A

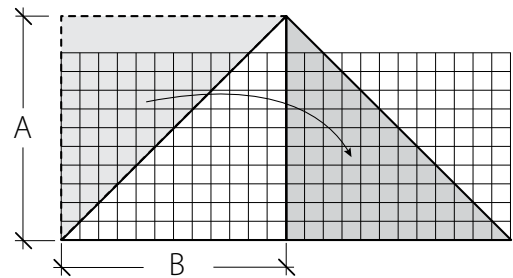

Illustration B

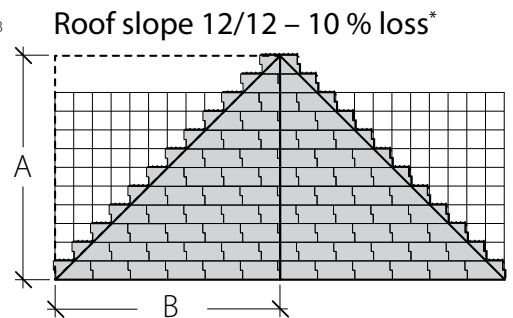
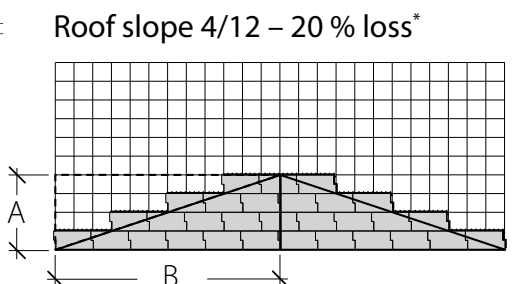
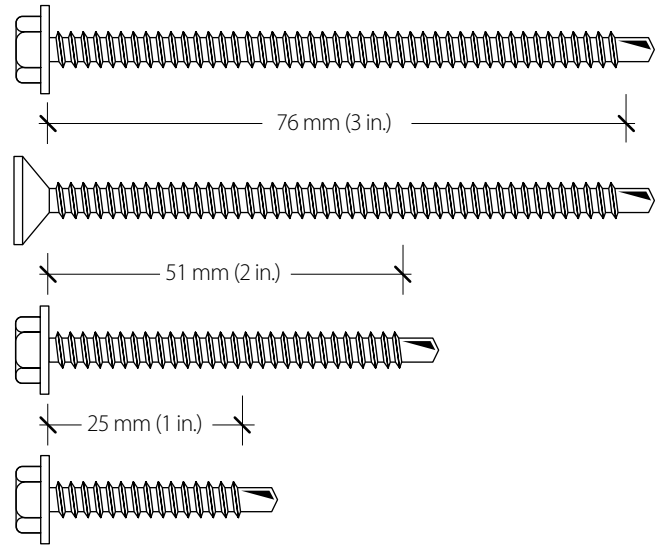
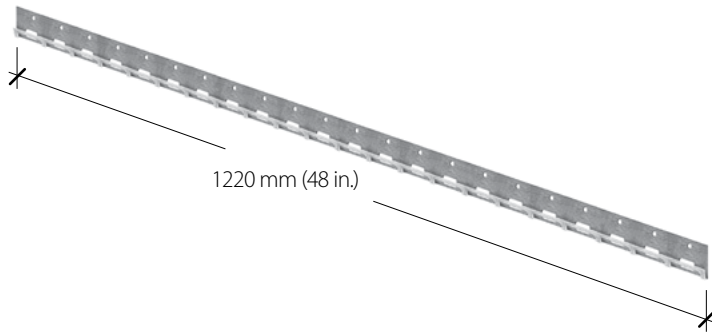

Illustration C



* Approximative loss



Starter strips

To calculate the number of starter strips required, measure the length of the wall to be covered (in feet) and divide by 4. Each starter strip is 1220 mm (48 in.) in length.

Example: $L (16 \text{ ft.}) \div 4 = 4 \text{ starter strips}$

Screws

To ensure the integrity of installation and durability, you should use the recommended screws presented in the chart below.

Wall type	Screw length	Screw type	Number of screws per panel
Standard framed wall + 1/2-inch plywood	25 mm (1 in.)	(1)	3
Standard framed wall + 7/16-inch OSB	25 mm (1 in.)	(1)	3
Standard framed wall + flexible siding (gypsum, insulation or bitumen board)	At least 32 mm (1 1/4 in.) penetration into the framing	(1)	At least 1 screw mandatory into the framing
Standard framed wall + 1/2-inch plywood + 1 1/2-to-2-inch rigid insulation	76 mm (3 in.)	(1)	3
Standard framed wall + 7/16-inch OSB + 1 1/2-to-2-inch rigid insulation	76 mm (3 in.)	(1)	3
Wall (metal, wood, concrete block, or other) with metal furring	25 mm (1 in.)	(2)	3
Concrete wall (pre-drill)	38 mm (1 1/2 in.)	(3)	3

(1) **Self-tapping anticorrosive wood screw (stainless steel or MAGNI galvanized treatment)** with a hex washer head in compliance with standard ANSI/ASME 18.6.1. Dimensions: #10 (0.190 in. exterior diameter) threaded right to the head and the correct length for the wall type.

(2) **Self-drilling and self-tapping anticorrosive metal screw (stainless steel or MAGNI galvanized treatment)** with a hex washer head in compliance with standard ASTM F593. Dimensions: #10 (0.190 in. exterior diameter) threaded right to the head.

(3) **Self-tapping anticorrosive concrete screw (stainless steel or MAGNI galvanized treatment)** with a hex washer head screw in compliance with standard ASTM E488. Dimensions: 1/4 in. (0.250 in. exterior diameter)

NOTE: Before installing Beonstone panelized stone siding, ensure that the plywood or OSB is properly attached to the framing with appropriate screws.

STEP 2

PREPARATION

2.1 Identify the type of wall

Before beginning the first step, ensure that the construction of the wall you intend to cover with Beonstone panelized stone siding meets industry standards.

There are many types of wall. You need to choose the correct screw for your wall so the installation complies with regulations and is secure. Check the table in section 1.1 to select the correct length and appropriate type of screw.

Here are some of the more common types of wall:

INTERIOR INSTALLATION

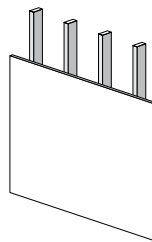

Standard framed wall with studs spaced 16 inches c/c covered with gypsum, OSB or 1/2-inch plywood

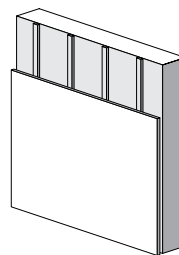

Concrete foundation with wood furring spaced 16 inches c/c covered with gypsum, OSB or 1/2-inch plywood

EXTERIOR INSTALLATION

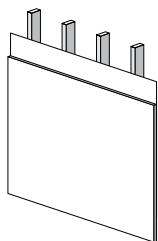

Standard framed wall with studs spaced 16 or 24 inches c/c covered with OSB or 1/2-inch plywood

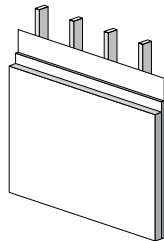

Standard framed wall with studs spaced 16 or 24 inches c/c covered with OSB or 1/2-inch plywood and 1 1/2-to-2-inch rigid insulation

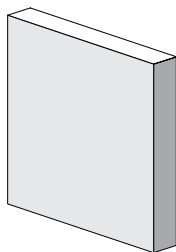

Poured or block concrete wall

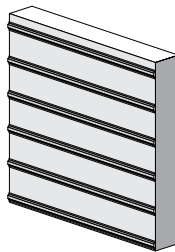

Poured or block concrete wall with horizontal metal furring

2.2 Condition of surface to be covered

It is very important to ensure the integrity of the surface to be covered. Thus we strongly recommend the installation of a water weather-resistant barrier (see the manufacturer's installation guide).



TIP FROM THE PROS

BEFOREHAND, ALL OPENINGS SHALL BE PROPERLY SEALED, THEREFORE PROTECTED AGAINST WATER INFILTRATION.

2.3 Marking the wall

(if you need to anchor in the frame)

Identify the type of wall to be covered and use an electronic detector or construction nails to locate the framing studs in the wall.

Starting at the first stud, measure and then use a pencil to mark the location of the framing with vertical or horizontal lines. These lines will serve as a guide so you can rapidly screw the panels in place.

You are now ready to install the starter strip.

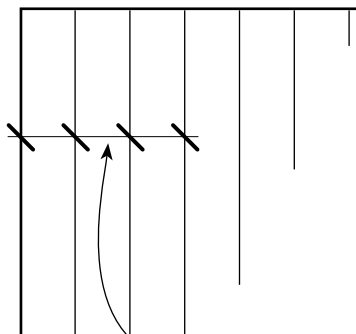

16 inches c/c

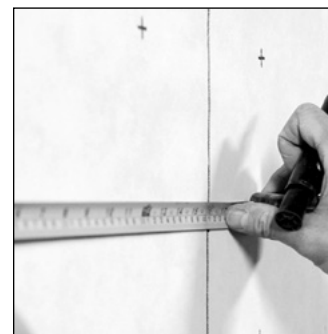

THE STARTER STRIP

2.4 Installing the starter strip

Now proceed to install the starter strip along the full length of the wall to be covered. This strip has perforations for draining any water that may infiltrate.

Using a laser or standard level, mark a horizontal line **215 mm (8 ½ in.)** above the floor planned base of the stone wall (Illustration A). This line marks the top of the starter strip.

Screw the starter strip in place. For a **standard framed wall with flexible siding** (gypsum, insulation or bitumen board), screw into every framing stud. For **other wall types**, screw every 305 mm (12 in.) for a solid installation. Leave a 6 mm (¼ in.) space between the strip and any openings to allow for normal expansion due to changes in temperature.

Apply a building cladding tape on the upper part of the starter strip.

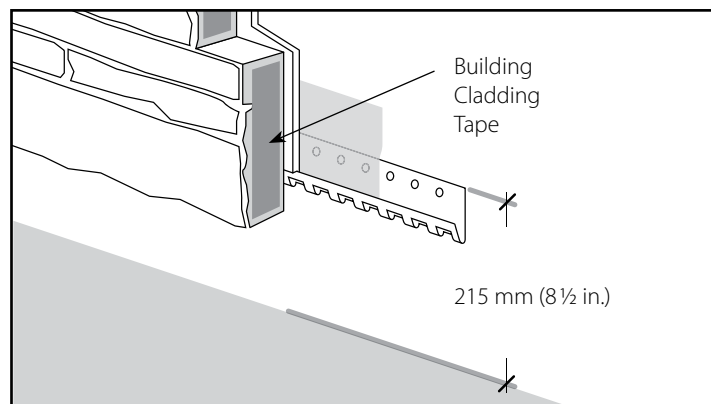
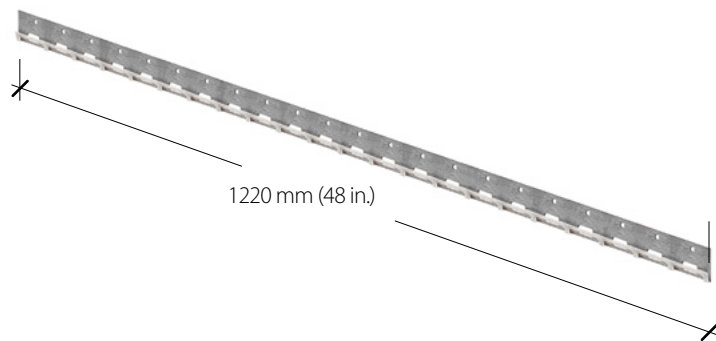
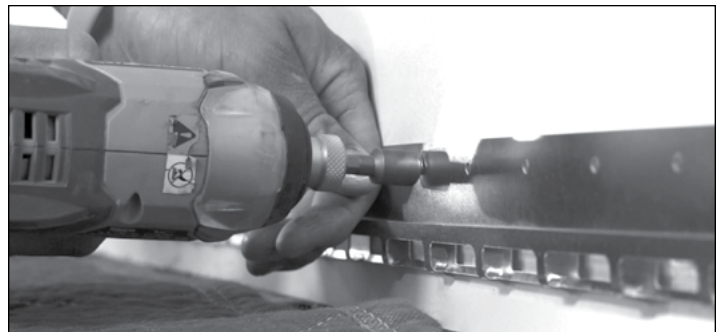

Illustration A



ATTENTION

WHEN INSTALLING AN INTERIOR WALL, SCREWING ONLY INTO THE DRYWALL IS NOT RECOMMENDED. IT IS IMPORTANT TO FASTEN SCREWS INTO THE WALL FRAMING.

STEP 3.1

WALL WITH NO CORNERS

3.1.1 The first row

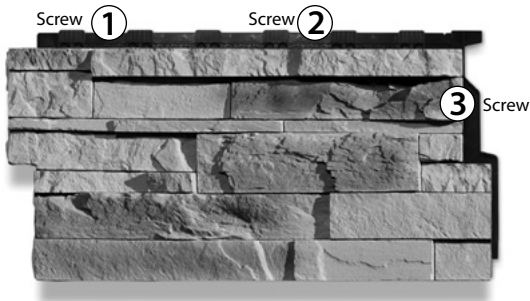

⚠ Beonstone requires two fasteners through the top plastic strip, and one through the vertical strip on the right-hand side.

Beonstone panelized stone siding are designed to interlock perfectly. To install the first row, simply anchor each panel in the starter strip.

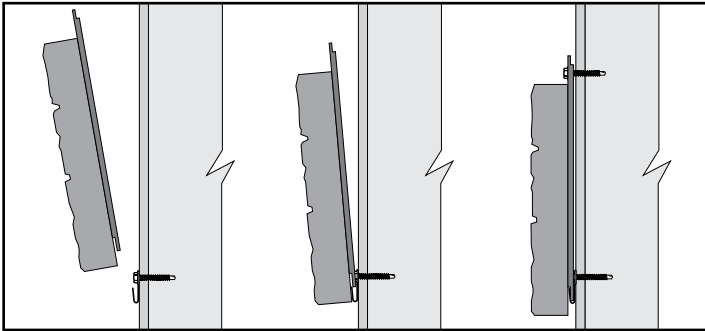

Cut a Beonstone panel and set it in place on the wall. Use three screws to fasten the panel into place. For all types of walls, be sure to fasten at least one screw in the framing. If the panel has been cut, only two screws are required.

Continue installing panels until the first row is complete (Illustrations A, B, C, D).



TIP FROM THE PROS

WE RECOMMEND TO ADEQUATELY MIX PANEL PROFILES TO AVOID REPETITION PATTERN.

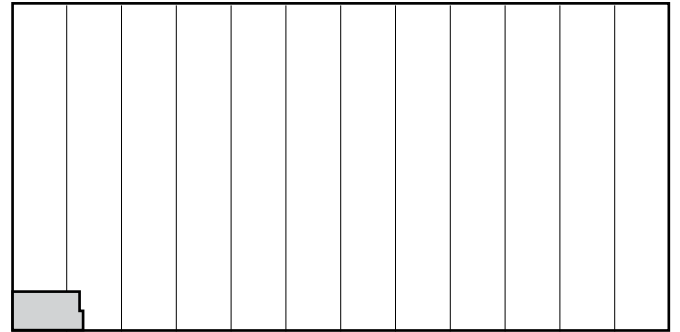

Illustration A

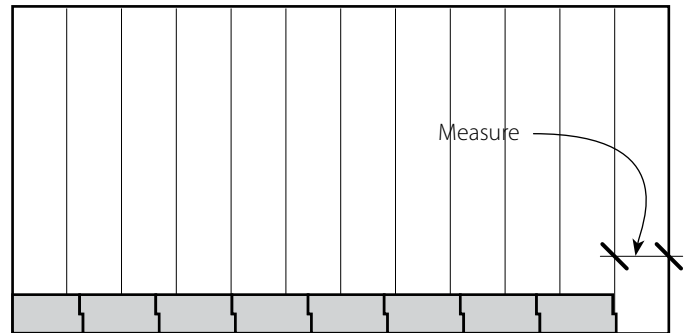

Illustration B

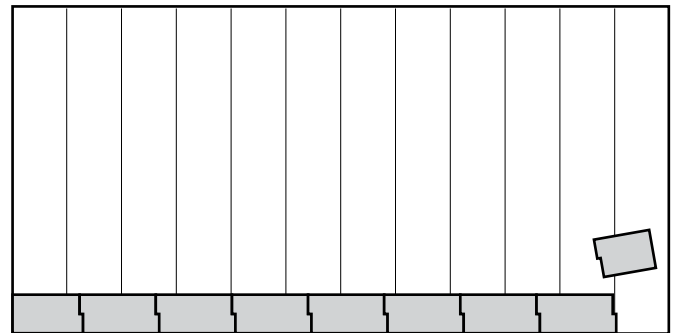

Illustration C

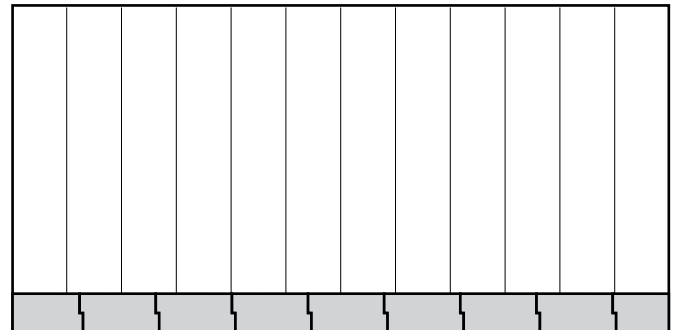

Illustration D

3.1.2 The second row

To ensure that the panels are positioned to reproduce the appearance of natural stone, it is important to offset the alignment of the vertical joints.

Cut a Beonstone panel in two and set one section in place to start the second row (Illustration E). Screw the panel in place.

Continue installing panels until the second row is complete (Illustration F). Continue with the subsequent rows until you are close to the top of the wall (Illustration G).

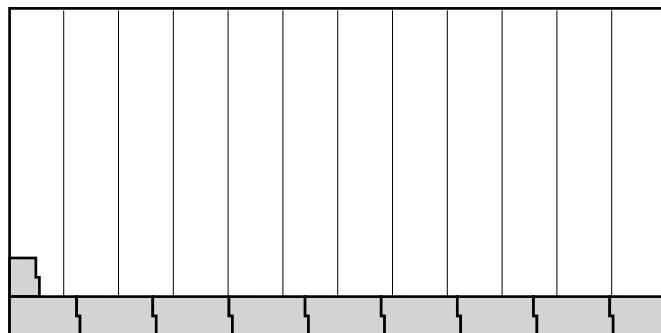
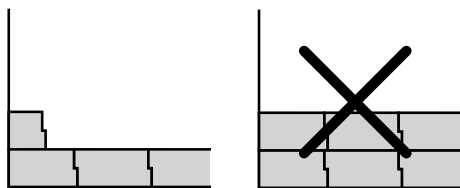

Illustration E

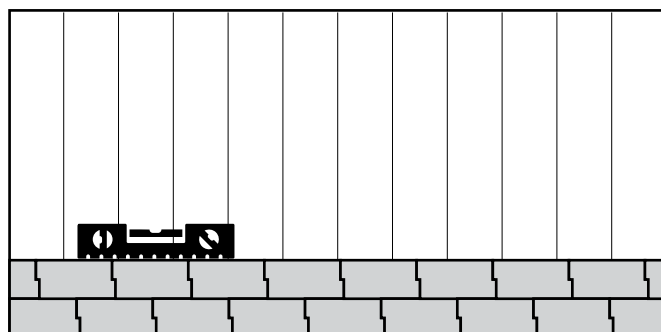

Illustration F

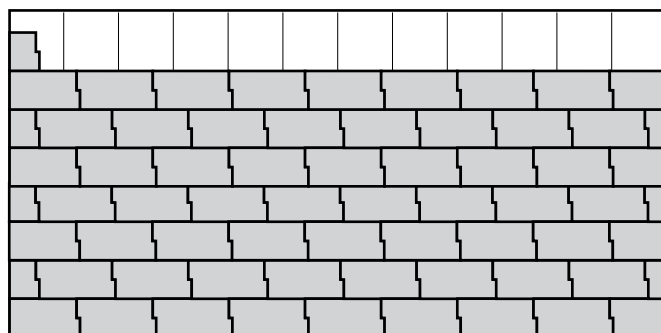

Illustration G



**TIP FROM THE PROS
FOR MAXIMUM PRECISION, WE RECOMMEND
CHECKING THE LEVEL AS EACH ROW IS
INSTALLED, ON THE CONCRETE AND NOT ON
THE PLASTIC EDGE OF IT.**



STEP 3.1

WALL WITH NO CORNERS (CONTINUED)

3.1.3 The final row

You have reached the last step in your wall project: installing the final row. To install this row, you need to cut Beonstone panelized stone siding lengthways.

Measure the space remaining from the last row installed to the top of the wall (Photo A) and cut a panel to fit.

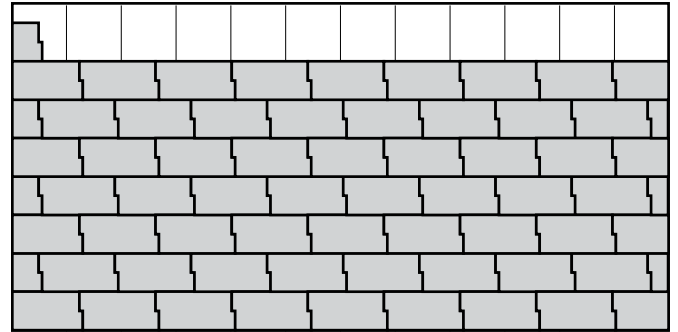
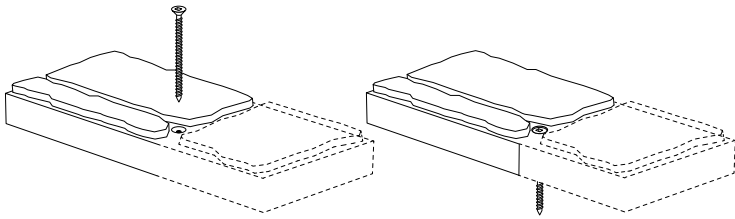

Illustration A

Pre-drill the panel (Photo B).

Use a countersink bit to create a bevelled hole for the screw head (Photo C).

Set the panel in position and screw it in place (Photos D and E).

Hide the screw heads with coloured caulking similar to the stone. You can create a perfect match by mixing some stone dust with a bit of transparent caulking.

Use screws that are 50 mm (2 in.) longer to attach the last row.

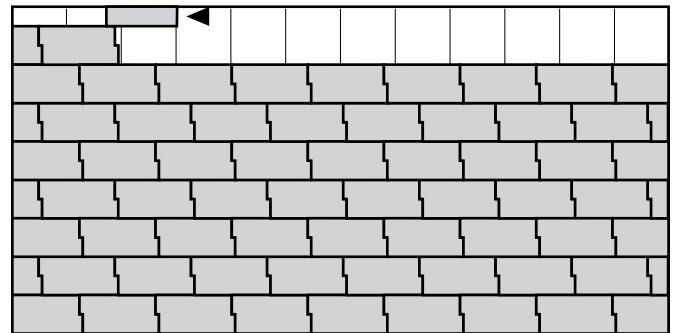

Illustration B

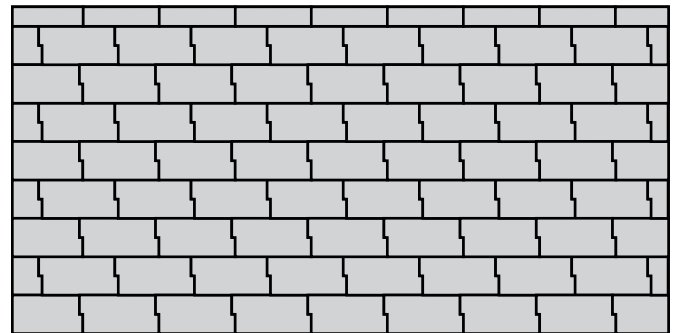

Illustration C



TIP FROM THE PROS

WE RECOMMEND THAT YOU INSTALL THE LAST TWO ROWS AT THE SAME TIME IN ORDER TO ALLOW ENOUGH SPACE TO SLIDE THE LAST PANEL INTO PLACE. LEAVE ¼ INCH BELOW THE CEILING OR FINISHED SURFACE TO FACILITATE INSERTION (Illustrations A, B, C).



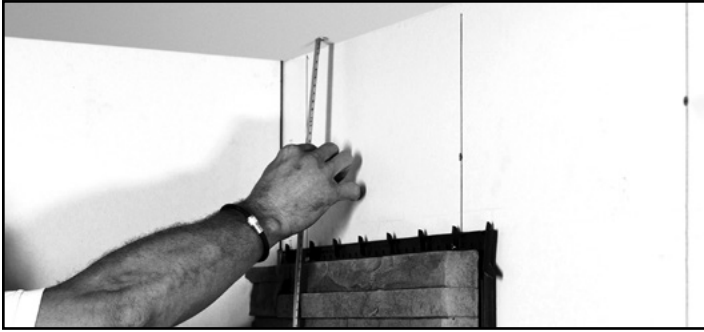

Photo A



Photo C



Photo B



Photo D

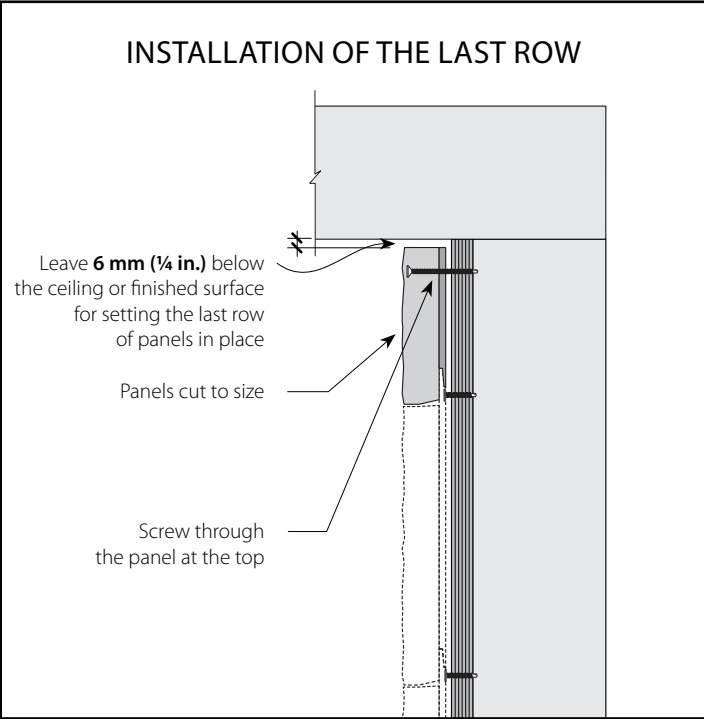

Photo E

STEP 3

WALL WITH AN EXTERIOR CORNER

3.2 Exterior corner

First, **apply an elastomeric waterproofing membrane air/water directly on the water weather-resistant barrier on both sides of the outside corner.** The elastomeric waterproofing membrane must cover a minimum of 100 mm (4 in.) on each side of the corner.

Beonstone panelized stone siding are designed to interlock perfectly. When forming an exterior corner, however, you need to prepare two panels by removing part of the plastic backing.

Preparing two panels for an EXTERIOR CORNER

Following the marks on the back of the panel, remove part of the plastic and metal backing with metal cutters (Panels A and B).

To ensure that the panels are positioned to reproduce the appearance of natural stone, cut the second Beonstone panel in two (Panel B).

Set the two panels in place to form a corner (Illustration A). Fasten the panels in place. Ensure that the panels are properly aligned and then finish screwing them in place.

When you make a straight cut in a panel (such as panel B), it is **IMPORTANT** to seal the joint with silicone to ensure that it is watertight (Illustration B).

Continue installing panels until the first row is complete (Illustrations C, D, E, F).

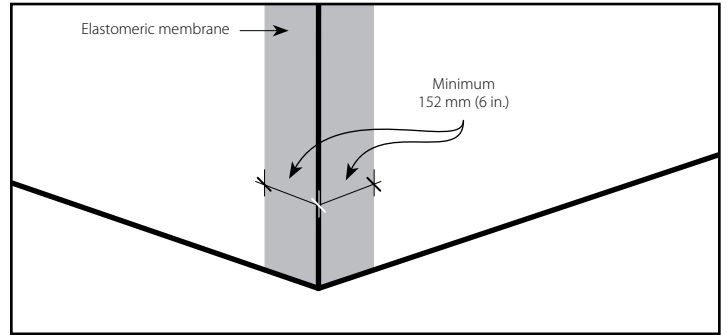

TIP FROM THE PROS

WHEN YOU CUT PANEL B, SET ASIDE THE REMAINING SECTION (B1) TO START THE SECOND ROW.

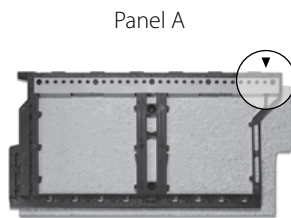
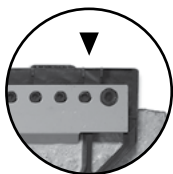
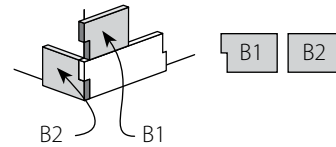

Panel A modified

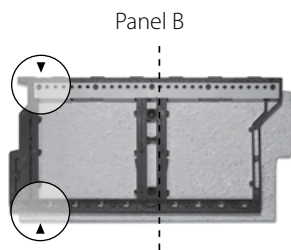
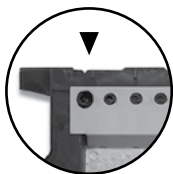
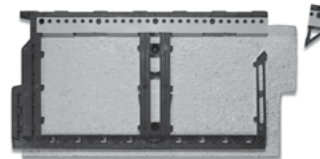

Panel B modified

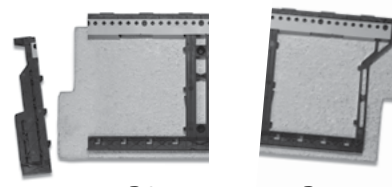

B2

B1

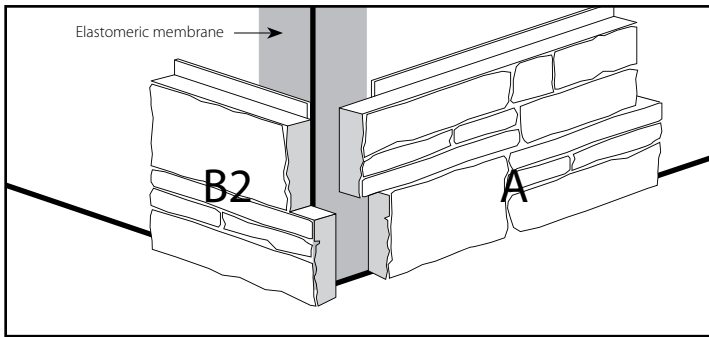

Illustration A

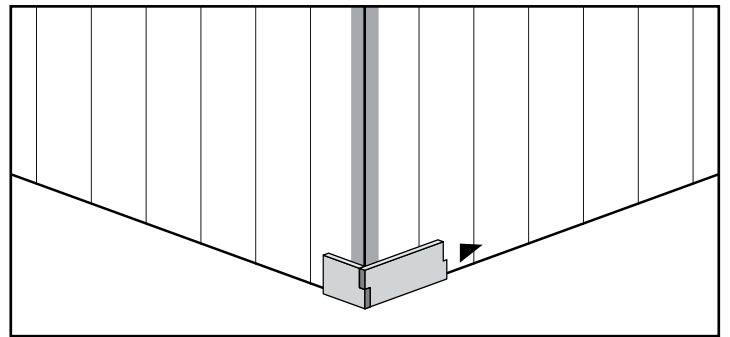

Illustration D

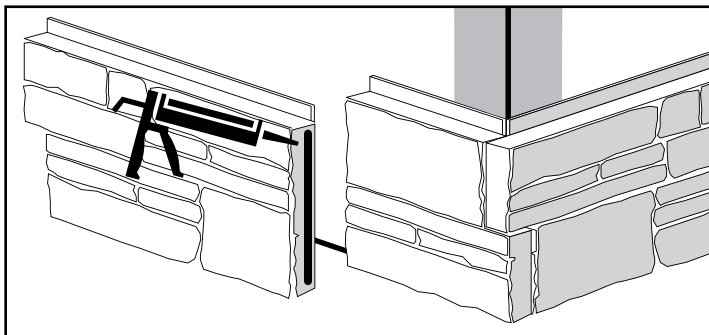

Illustration B

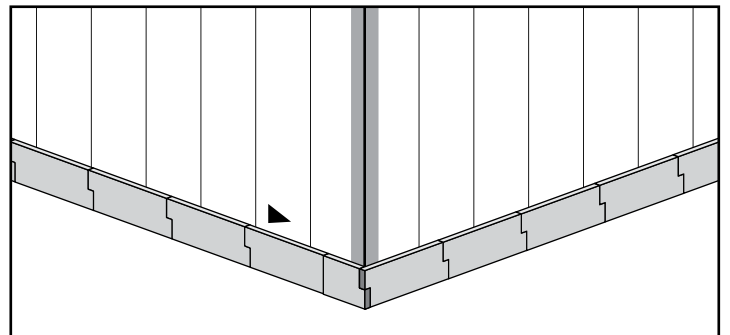

Illustration E

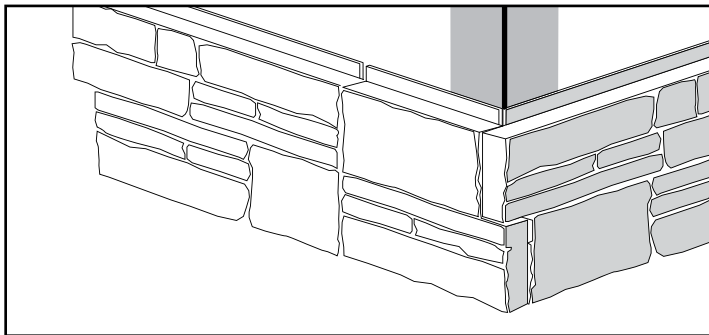

Illustration C

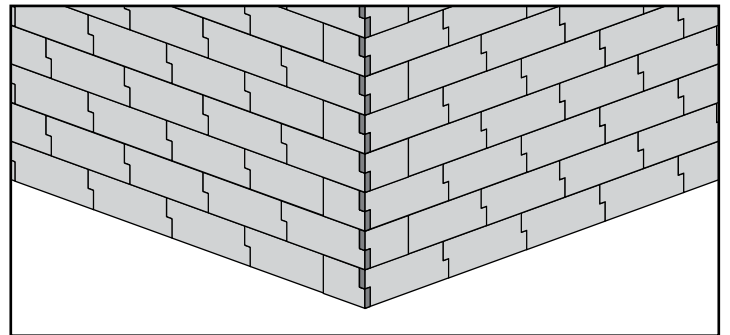

Illustration F



WHEN YOU MAKE A STRAIGHT CUT IN A PANEL (SUCH AS PANEL B), IT IS IMPORTANT TO SEAL THE JOINT WITH SILICONE TO ENSURE THAT IT IS WATERTIGHT.

STEP 3

WALL WITH AN INTERIOR CORNER

3.3 Interior corner

First, **apply an elastomeric waterproofing membrane air/water directly on the water weather-resistant barrier on both sides of the inside corner.** The elastomeric waterproofing membrane must cover a minimum of 175 mm (7 in.) on each side of the corner.

Beonstone panelized stone siding are designed to interlock perfectly. When forming an interior corner, however, you need to prepare one panel by removing part of the plastic backing.

Preparing two panels for an INTERIOR CORNER

Following the marks on the back of the panel, remove part of the plastic and metal backing with metal cutters (Panel B).

To ensure that the panels are positioned to reproduce the appearance of natural stone, cut the second Beonstone panel in two (Panel B).

Set the two panels in place to form a corner (Illustration A). Fasten the panels in place. Ensure that the panels are properly aligned and then finish screwing them in place.

When you make a straight cut in a panel (e.g., panel B), it is **IMPORTANT** to seal the joint with silicone to ensure that it is watertight (Illustration B).

Continue installing panels until the first row is complete (Illustrations C, D, E, F).

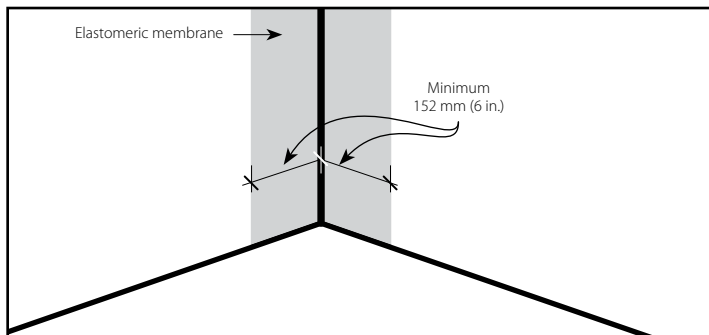

TIP FROM THE PROS

WHEN YOU CREATE AN INSIDE CORNER, IT IS RECOMMENDED TO USE THE BLOCKS SPECIALLY MARKED WITH A POINT TO OBTAIN AN AESTHETIC AND EFFICIENT JOINT.



TIP FROM THE PROS

WHEN YOU CUT PANEL B, SET ASIDE THE REMAINING SECTION (B1) TO START THE SECOND ROW.

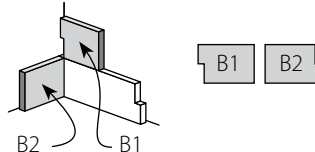

Panel A

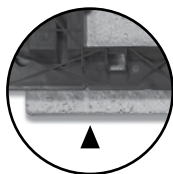
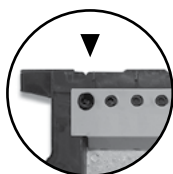
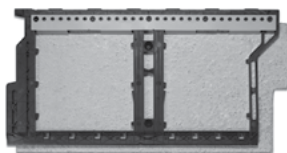

Panel B

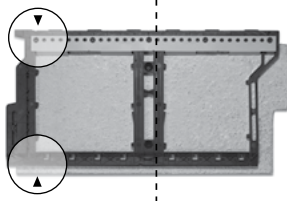

Panel B modified

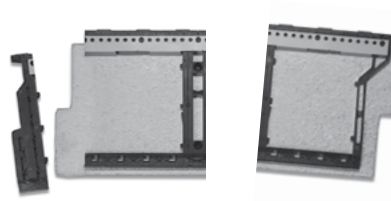

B2

B1



TIP FROM THE PROS – WHEN YOU CREATE AN INSIDE CORNER, YOU MAY OCCASIONALLY USE A GRINDER (BUFFER) TO OBTAIN JOINTS LESS THAN 3 MM (1/8 IN.) BETWEEN THE ARCHITECTURAL PANELS.

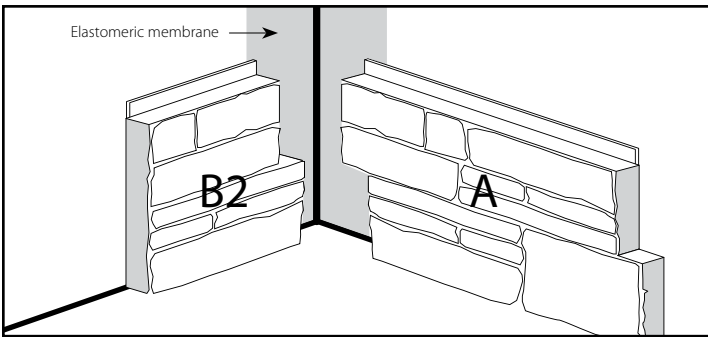

Illustration A

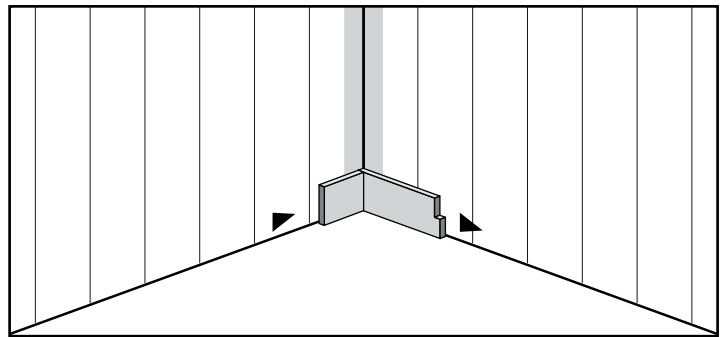

Illustration D

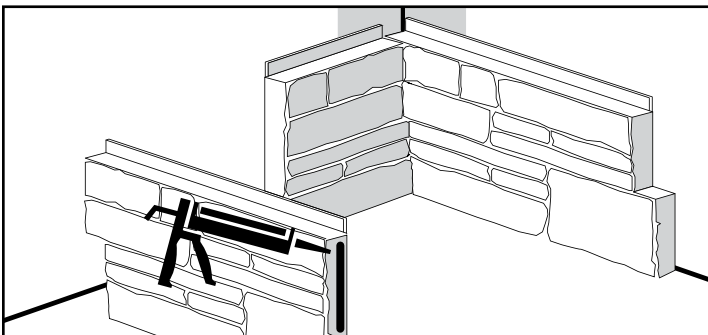

Illustration B

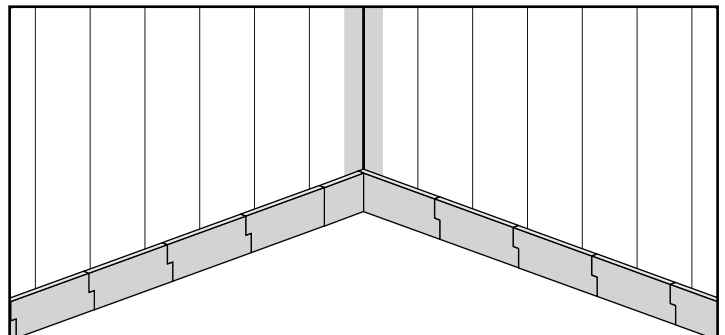

Illustration E

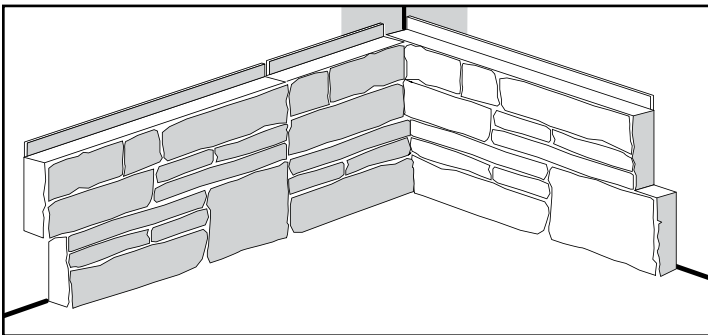

Illustration C

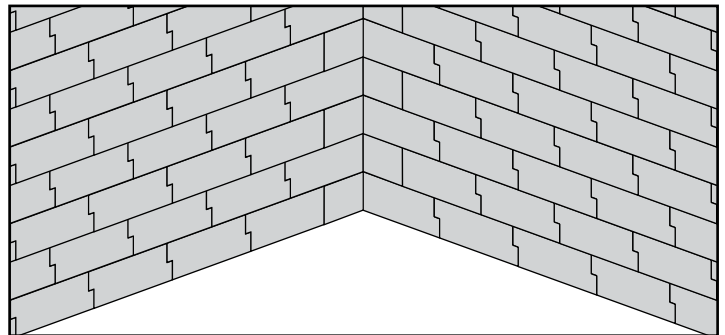

Illustration F



WHEN YOU MAKE A STRAIGHT CUT IN A PANEL (e.g., PANEL B), IT IS IMPORTANT TO SEAL THE JOINT WITH SILICONE TO ENSURE THAT IT IS WATERTIGHT.

STEP 4

ARCHITECTURAL DETAILS

4.1 Beonstone sill caps

Window and transition sill caps play an important role in preventing any possible infiltration by water.

Beonstone sill caps are designed for easy installation and provide the watertight protection required by exterior walls. Their unique form features a 3° slope to drain water away from the wall.

A metal strip embedded in the back of sill caps makes them easy to install with Beonstone panelized stone siding.

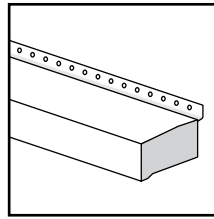

Transition sill cap

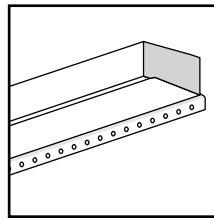
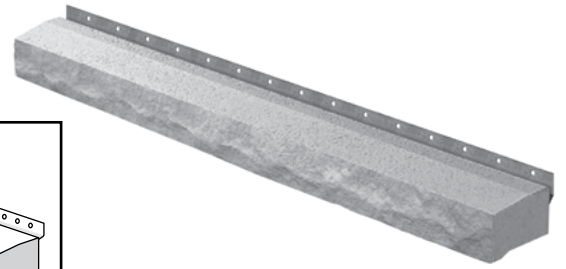

Window sill cap

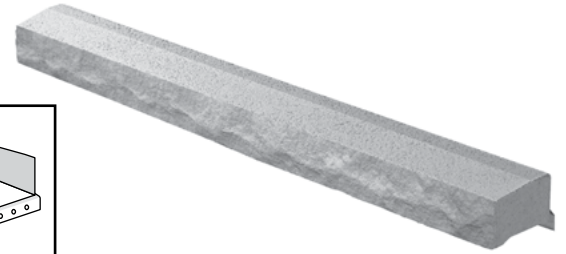

TIP FROM THE PROS

WHEN MULTIPLE PARTS ARE REQUIRED (WINDOW SILL OR TRANSITION) IT IS VERY IMPORTANT TO SEAL THE ENDS WITH A CLEAR SEALANT.



RECOMMENDED FINISH

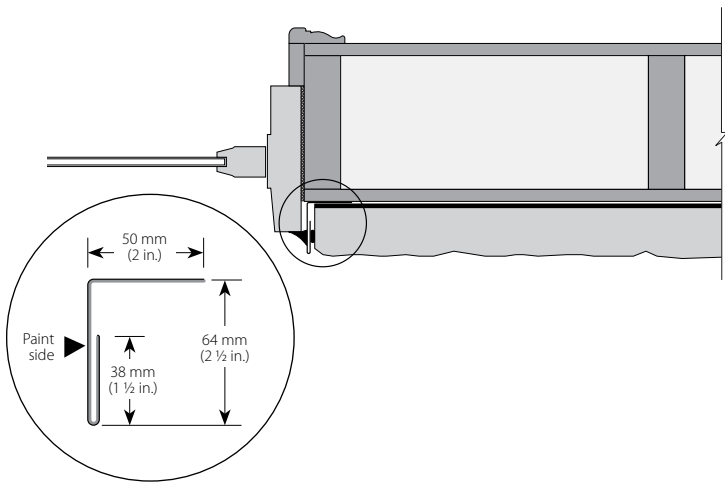

FINISH WITH ALUMINUM MOLDING

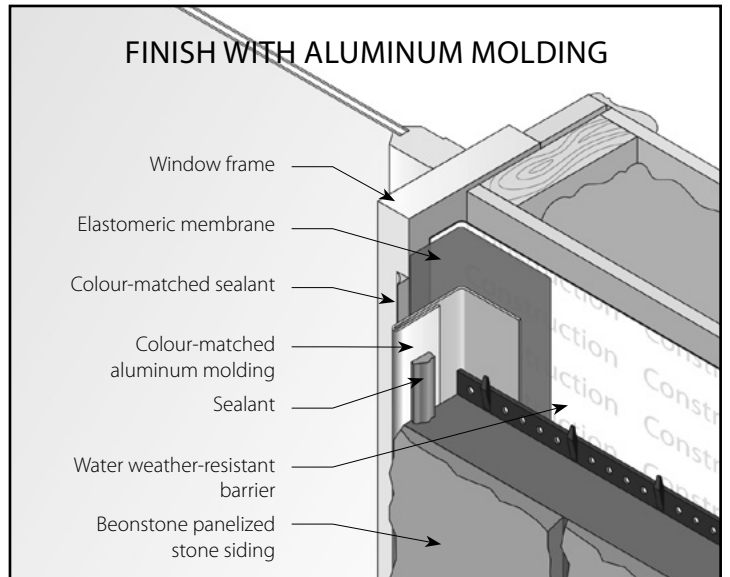

FINISH WITH WINDOW SURROUND

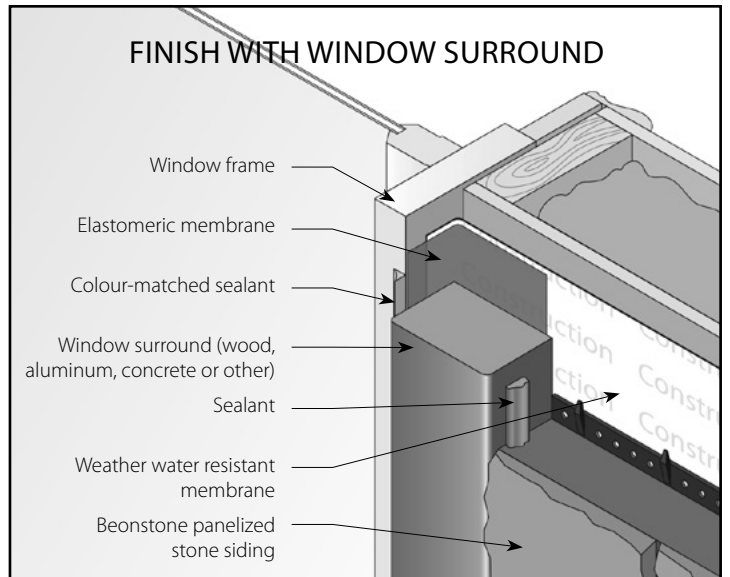

In a new construction, we recommend that part of the window pops 50 mm (2 in.) relative to the water weather-resistant barrier.

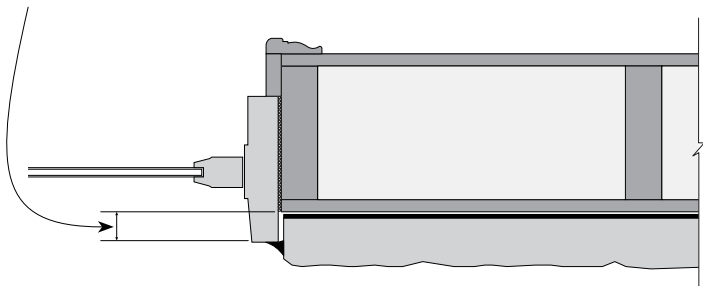

FINISH WITHOUT MOLDING

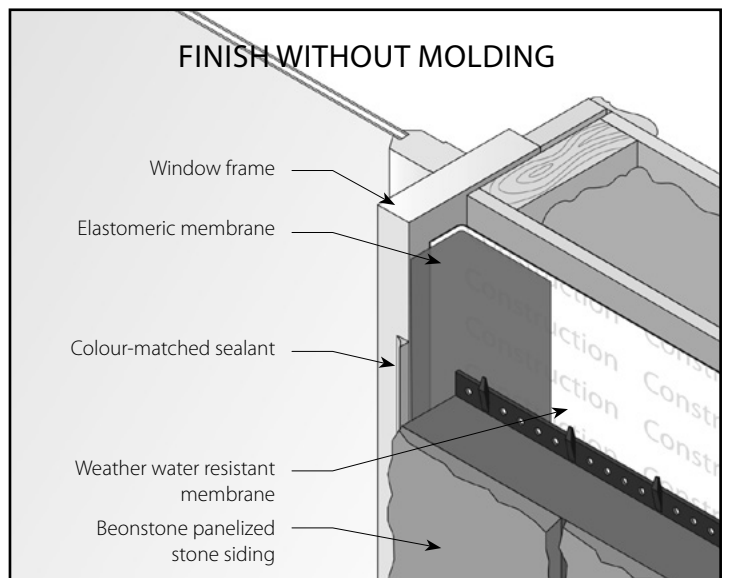

STEP 4

ARCHITECTURAL DETAILS (CONTINUED)

4.2 Installing around a window or door

When the wall you are covering includes a window, we recommend that you install Beonstone sill caps before the final row of panels under the window (Illustration A).

Measure the distance between the last row of Beonstone panels and the bottom of the sill cap (Illustration A). To shape the first piece for under the window, you will need to make two cuts in a stone panel (Illustration B). Allow 3 mm (1/8 in.) clearance between the window and the sill cap. Seal around the sill cap carefully.



To install the next piece, measure the height between the last row and the bottom of the sill cap, and cut a panel lengthways to fit.

Slide the piece into position (Illustration C) and screw it in place. Follow the instructions for installing a final row of panelling (see pages 12–13) by pre-drilling the panel (Photo A).

Use a countersink bit to create a bevelled hole for the screw head (Photo B).

Set the panel in position and screw it in place (Photo C).

Hide the screw heads with caulking of a colour similar to that of the stone. You can create a perfect match by mixing some stone dust with a bit of transparent caulking.



Photo A



Photo B



Photo C

Continue adding rows until you reach the top of the window. Be very accurate in cutting panels.

To prevent the panels over the window from rocking, screw them at the bottom as well as through the plastic anchor strip (Illustration D). Follow the same procedure as for a final row (see pages 12–13). Refer to the cross-section on page 27 for installation details.

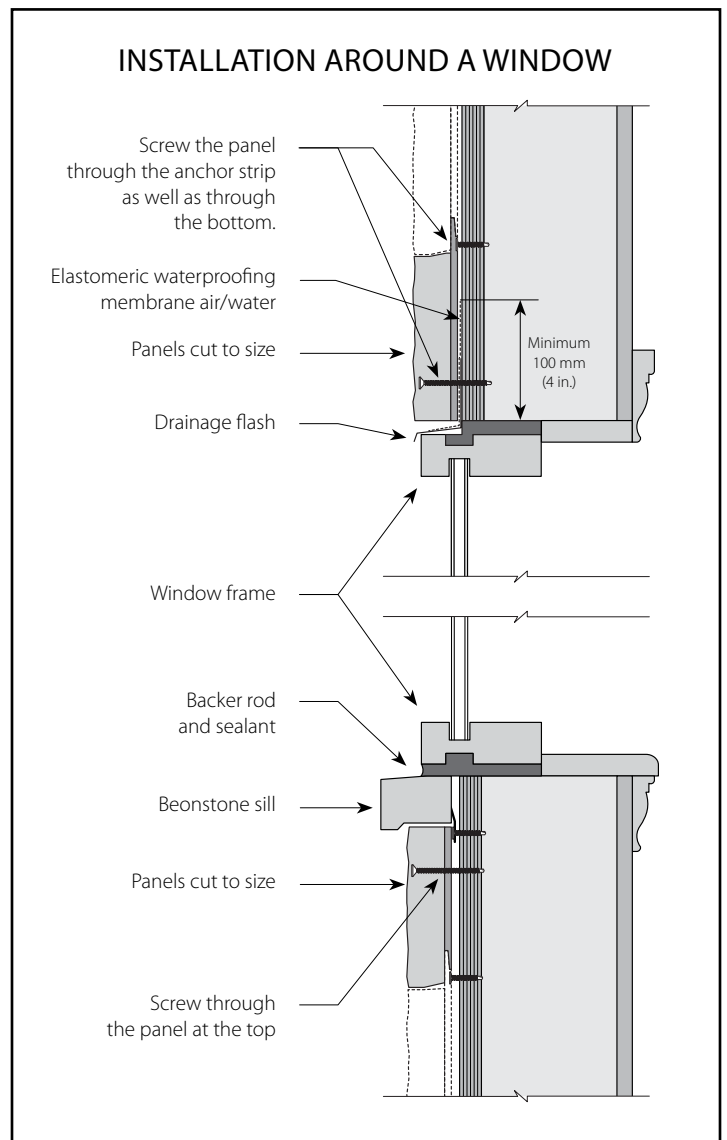
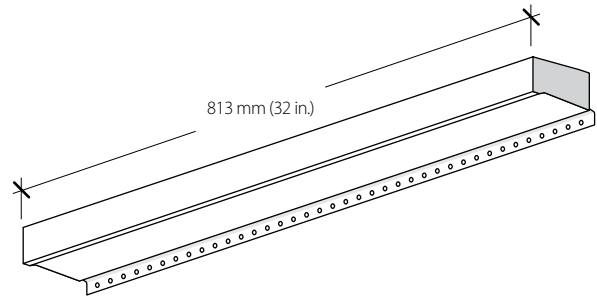

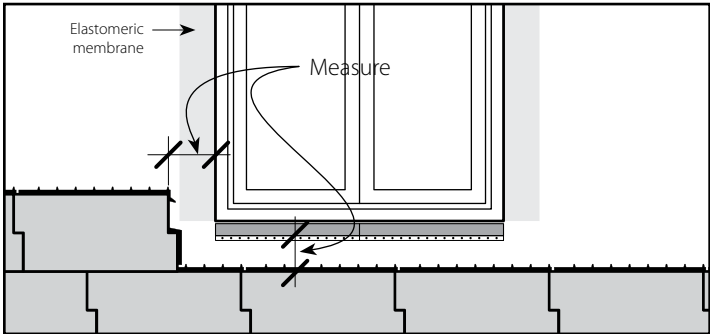

Illustration A

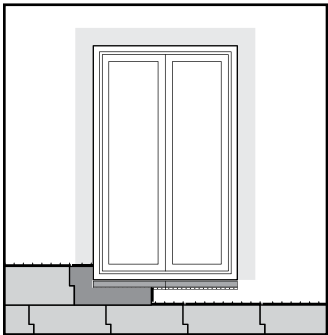
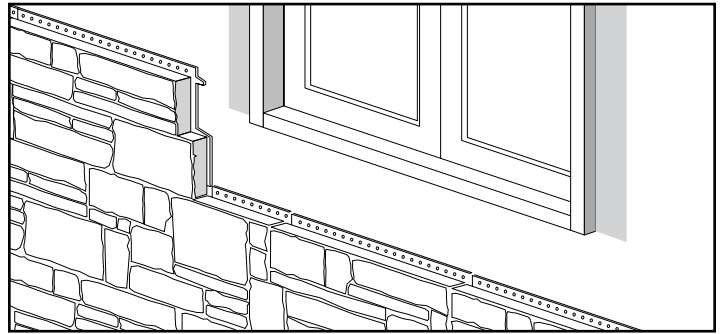

Illustration B

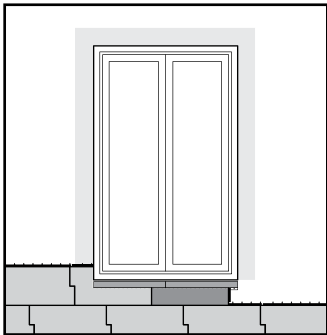

Illustration C

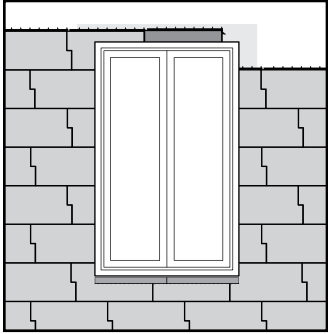
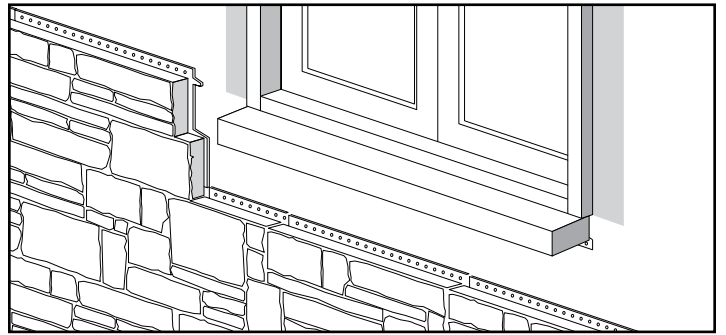

Illustration D

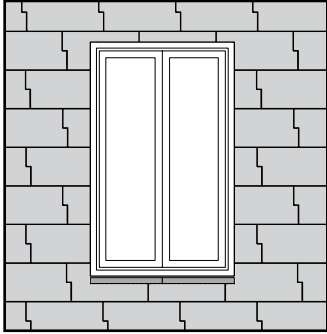
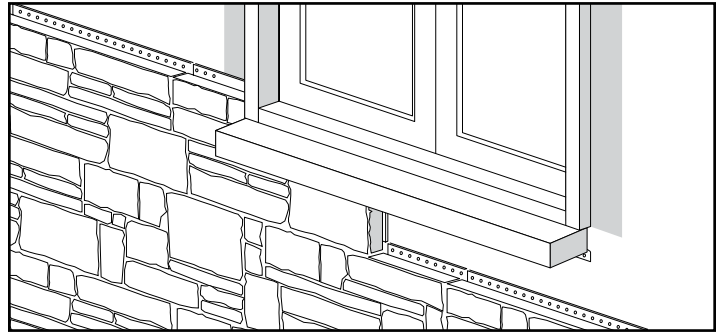

Illustration E



STEP 4

ARCHITECTURAL DETAILS (CONTINUED)

4.3 Installing a transition sill cap

First, **apply an elastomeric waterproofing membrane air/water over the transition sill cap.** The elastomeric waterproofing membrane must cover a minimum of 25 mm (1 in.) and a minimum of 100 mm (4 in.) against the back wall (see detailed cross section p. 25).

If you are covering only the lower part of a wall with Beonstone panelized stone siding, it is important to install a sill cap to ensure a watertight transition. Install Beonstone panelized stone siding up to the desired height (Illustration A). Set the sill cap on top of the last row and screw in place (Illustration B).

Refer to the cross-section on page 25 for installation details.

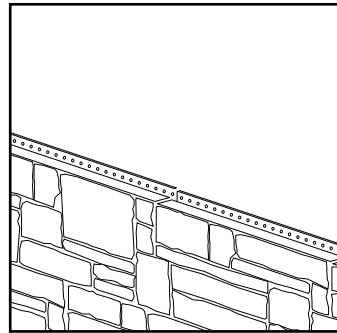
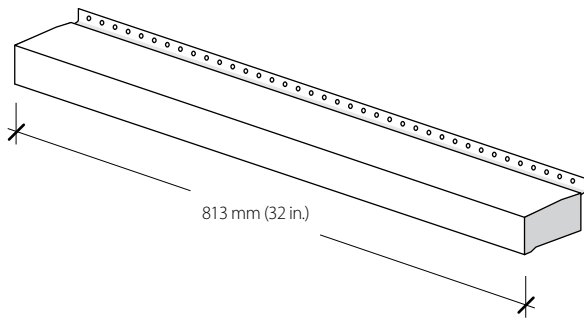

Illustration A

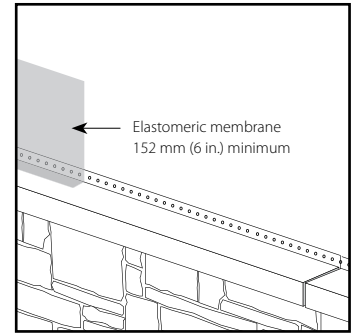

Illustration B

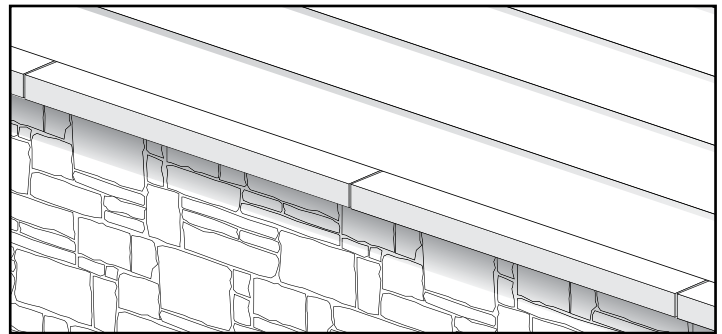

Illustration C

4.4 Column and protruding wall

During the construction of a column, it is strongly recommended to use an optimal rough dimension of 545 mm (20 3/4 in.) to minimize cuts and get an aesthetically perfect finish (the overall column dimension will be 650 mm (25 1/4 in.) x 650 mm (25 1/4 inches)).

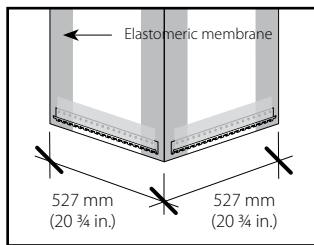

Illustration A

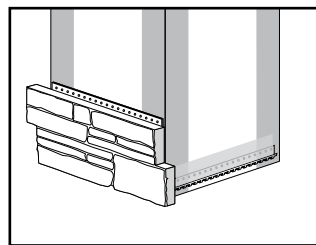

Illustration B

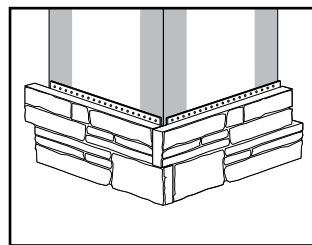

Illustration C

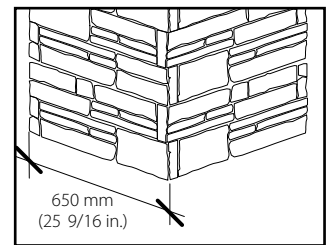

Illustration D

If you choose to build a protruded wall surface such as a fireplace or an architectural detail, it is recommended to use optimal dimension such as of 610 mm (24 in.) to minimize cuts and get an aesthetically perfect finish.

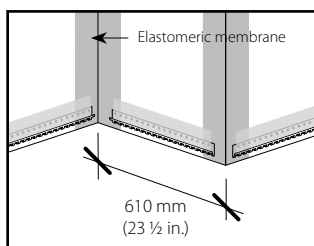

Illustration A

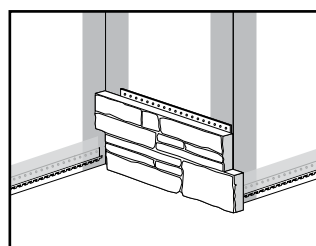

Illustration B

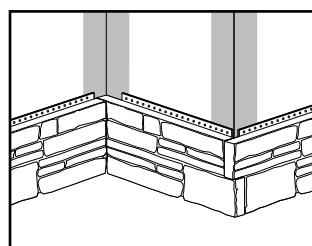

Illustration C

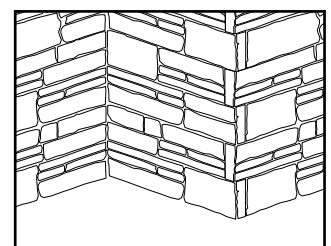

Illustration D



COMPLEMENTARY PRODUCTS

4.5 Discover the world of Beonstone!

Discover the world of Beonstone, where attention to detail makes the difference. Beonstone panelized stone siding are paired with special accessories designed to improve your living space.

These timeless accessories are manufactured from high-quality concrete of a neutral shade that matches all Beonstone products and colours. They make it easy to install wall outlets and outdoor lighting.

All you have to do is carefully measure the space required, then cut an opening in the panel. We recommend making the opening a bit larger than the plate, about 6 mm (¼ in.).

Use a concrete grinder and a drill to make an opening in the centre of a panel.

Panels with an opening for a receptacle are installed in the same manner as any other panel.

Use PL adhesive to fasten the plate in place and ensure that it is watertight.

These accessories can also be used for indoor projects.

Beonstone brings a contemporary look to stone!



TIP FROM THE PROS

BE SURE TO PROPERLY SEAL THE UPPER PARTS OF ACCESSORIES WITH AN ELASTOMERIC WATERPROOFING MEMBRANE.

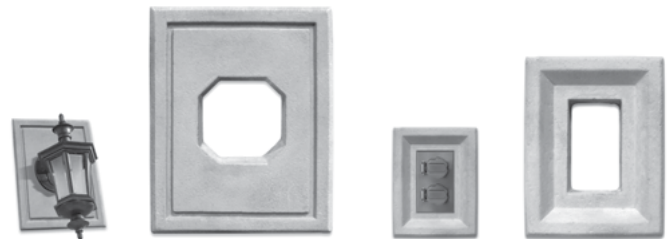
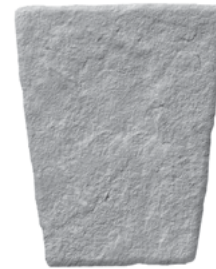

Lighting fixture plate		Electrical outlet plate	
Width	200 mm (8 in.)	Width	153 mm (6 in.)
Height	254 mm (10 in.)	Height	200 mm (8 in.)
Depth	51 mm (2 in.)	Depth	51 mm (2 in.)

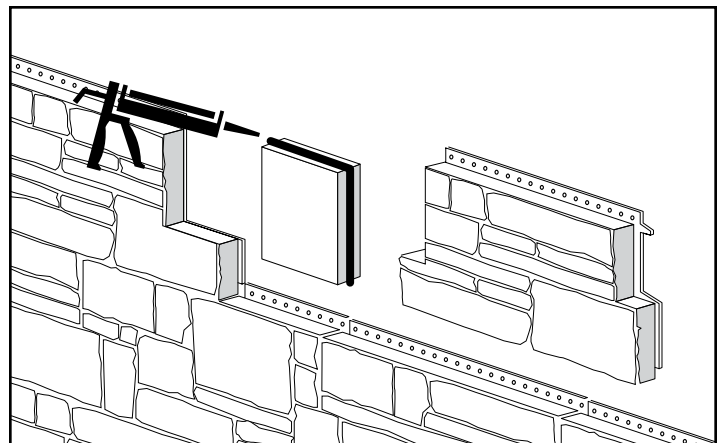

Note: screw fasteners are to be minimum #10 x 25 mm (1 in.), corrosion-resistant type unless otherwise noted.

Slide and lock in place upper Beonstone Panel into locking clips at top of nailer strips of Beonstone panel below.

Screw fastener over the nailer strips into wood sheathing (provide minimum three fasteners per panel).

Beonstone panelized stone siding

Water weather-resistant barrier

Wood sheathing, minimum 13-mm (½-in.) thickness

Apply a building cladding tape on the upper part of the starter strip.

Screw fastener track using 38 mm (1 ½ in.) masonry screw fastener (e.g. Tapcon®) directly into concrete foundation wall @ 406 mm (16 in.) O.C.

Starter strip

Minimum 200 mm (8 in.) clearance required above grade level

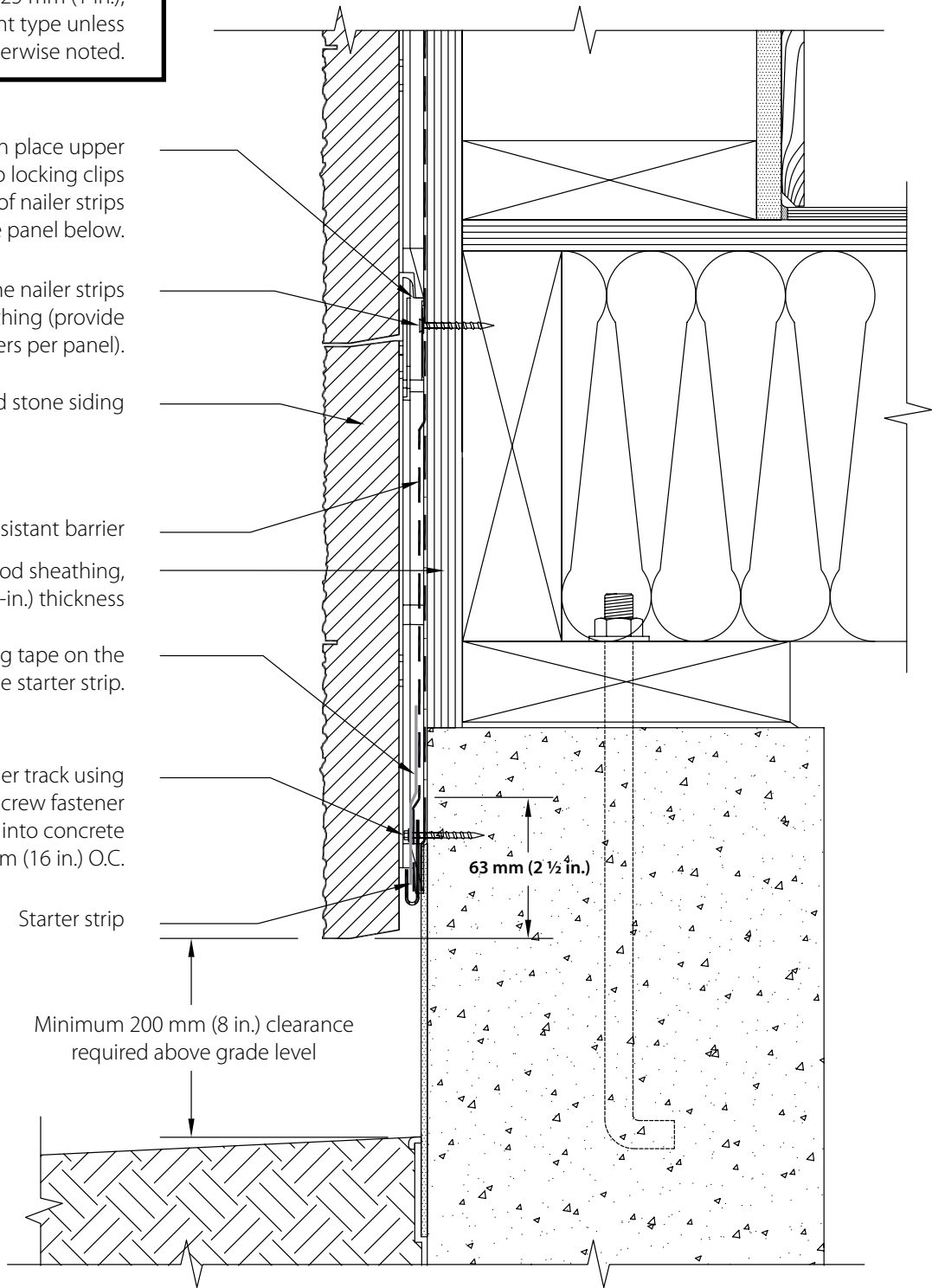

DISCLAIMER: BEONSTONE HAS PRODUCED THIS DETAIL AS AN ARCHITECTURAL GUIDE FOR THE SELECTION OF BEONSTONE PRODUCTS AND SYSTEMS. IT MUST BE MODIFIED AND ADAPTED FOR USE IN SPECIFIC PROJECTS, IN PARTICULAR WHERE GOVERNING CODES AND STANDARDS MAY HAVE ADDITIONAL REQUIREMENTS. BEONSTONE IS NOT LIABLE FOR DESIGN AND WORKMANSHIP ASSOCIATED WITH THE USE OF THIS DETAIL. PLEASE REFER TO BEONSTONE.COM FOR LATEST REVISIONS.

WOOD STUDS WITH WOOD SHEATHING (FOR LOW RISE RESIDENTIAL CONSTRUCTION)
SECTION DETAIL – WALL BASE AT FOUNDATION WALL

be on
stone

Note: screw fasteners are to be minimum #10 x 25 mm (1 in.), corrosion-resistant type unless otherwise noted.

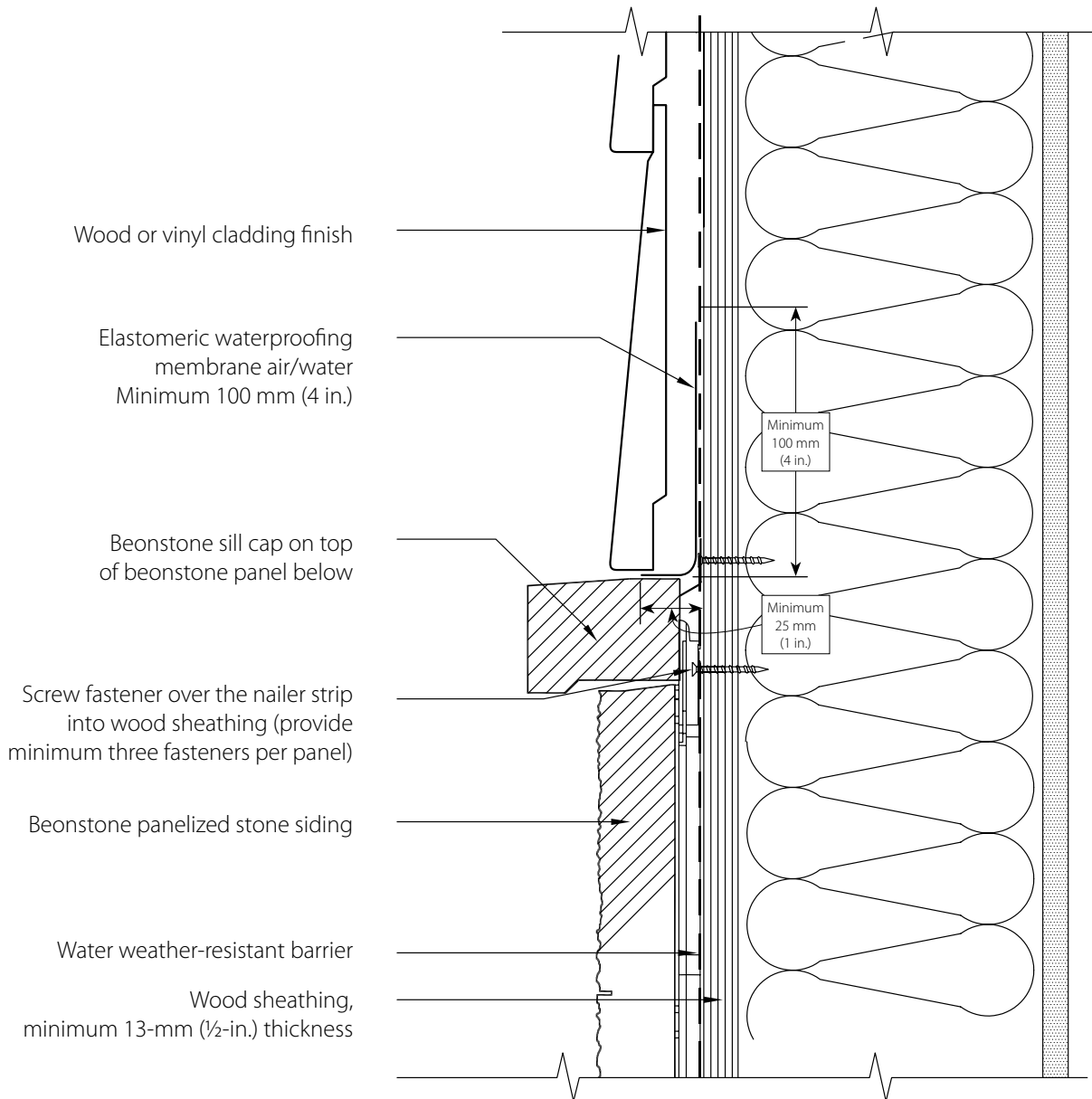

DISCLAIMER: BEONSTONE HAS PRODUCED THIS DETAIL AS AN ARCHITECTURAL GUIDE FOR THE SELECTION OF BEONSTONE PRODUCTS AND SYSTEMS. IT MUST BE MODIFIED AND ADAPTED FOR USE IN SPECIFIC PROJECTS, IN PARTICULAR WHERE GOVERNING CODES AND STANDARDS MAY HAVE ADDITIONAL REQUIREMENTS. BEONSTONE IS NOT LIABLE FOR DESIGN AND WORKMANSHIP ASSOCIATED WITH THE USE OF THIS DETAIL. PLEASE REFER TO BEONSTONE.COM FOR LATEST REVISIONS.

WOOD STUDS WITH WOOD SHEATHING (FOR LOW RISE RESIDENTIAL CONSTRUCTION)
SECTION DETAIL – HORIZONTAL TRANSITION WITH SILL CAP

be on
stone

Note: screw fasteners are to be minimum #10 x 25 mm (1 in.), corrosion-resistant type unless otherwise noted.

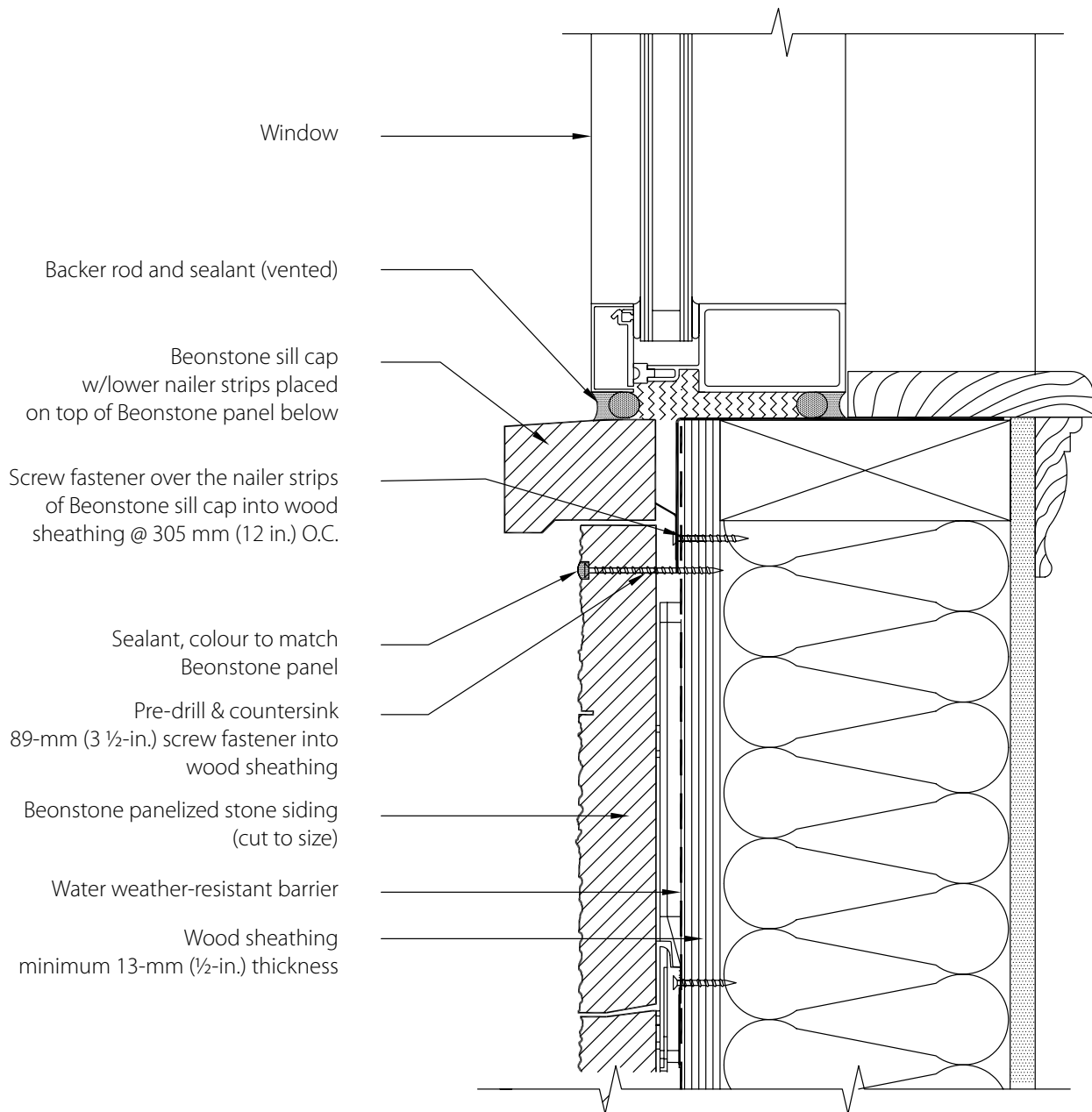

DISCLAIMER: BEONSTONE HAS PRODUCED THIS DETAIL AS AN ARCHITECTURAL GUIDE FOR THE SELECTION OF BEONSTONE PRODUCTS AND SYSTEMS. IT MUST BE MODIFIED AND ADAPTED FOR USE IN SPECIFIC PROJECTS, IN PARTICULAR WHERE GOVERNING CODES AND STANDARDS MAY HAVE ADDITIONAL REQUIREMENTS. BEONSTONE IS NOT LIABLE FOR DESIGN AND WORKMANSHIP ASSOCIATED WITH THE USE OF THIS DETAIL. PLEASE REFER TO BEONSTONE.COM FOR LATEST REVISIONS.

WOOD STUDS WITH WOOD SHEATHING (FOR LOW RISE RESIDENTIAL CONSTRUCTION)
SECTION DETAIL – WINDOW SILL

be on
stone

Note: screw fasteners are to be minimum #10 x 25 mm (1 in.), corrosion-resistant type unless otherwise noted.

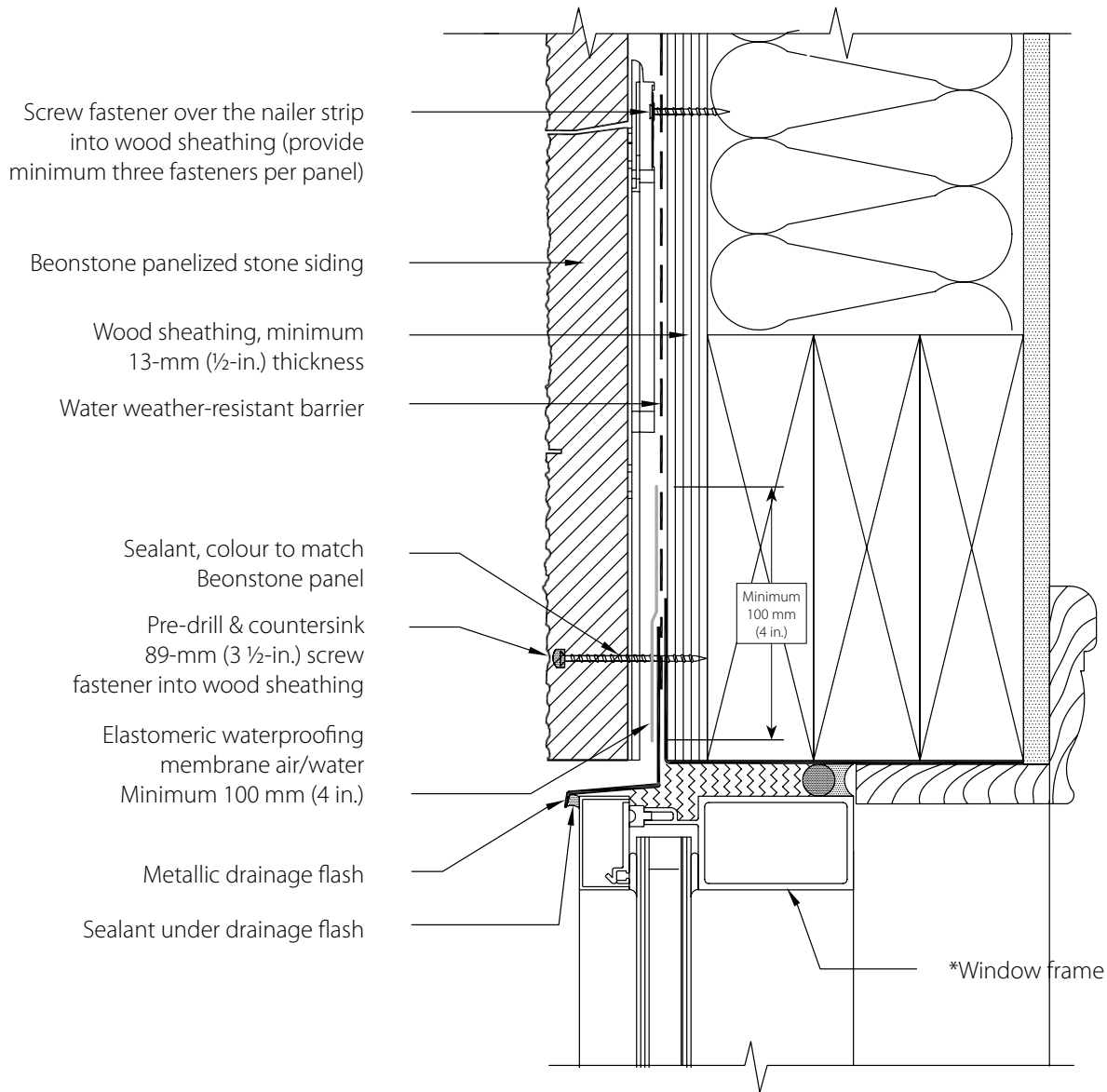

DISCLAIMER: BEONSTONE HAS PRODUCED THIS DETAIL AS AN ARCHITECTURAL GUIDE FOR THE SELECTION OF BEONSTONE PRODUCTS AND SYSTEMS. IT MUST BE MODIFIED AND ADAPTED FOR USE IN SPECIFIC PROJECTS, IN PARTICULAR WHERE GOVERNING CODES AND STANDARDS MAY HAVE ADDITIONAL REQUIREMENTS. BEONSTONE IS NOT LIABLE FOR DESIGN AND WORKMANSHIP ASSOCIATED WITH THE USE OF THIS DETAIL. PLEASE REFER TO BEONSTONE.COM FOR LATEST REVISIONS.

WOOD STUDS WITH WOOD SHEATHING (FOR LOW RISE RESIDENTIAL CONSTRUCTION)
SECTION DETAIL – WINDOW HEADER

be on
stone

Note: screw fasteners are to be minimum #10 x 25 mm (1 in.), corrosion-resistant type unless otherwise noted.

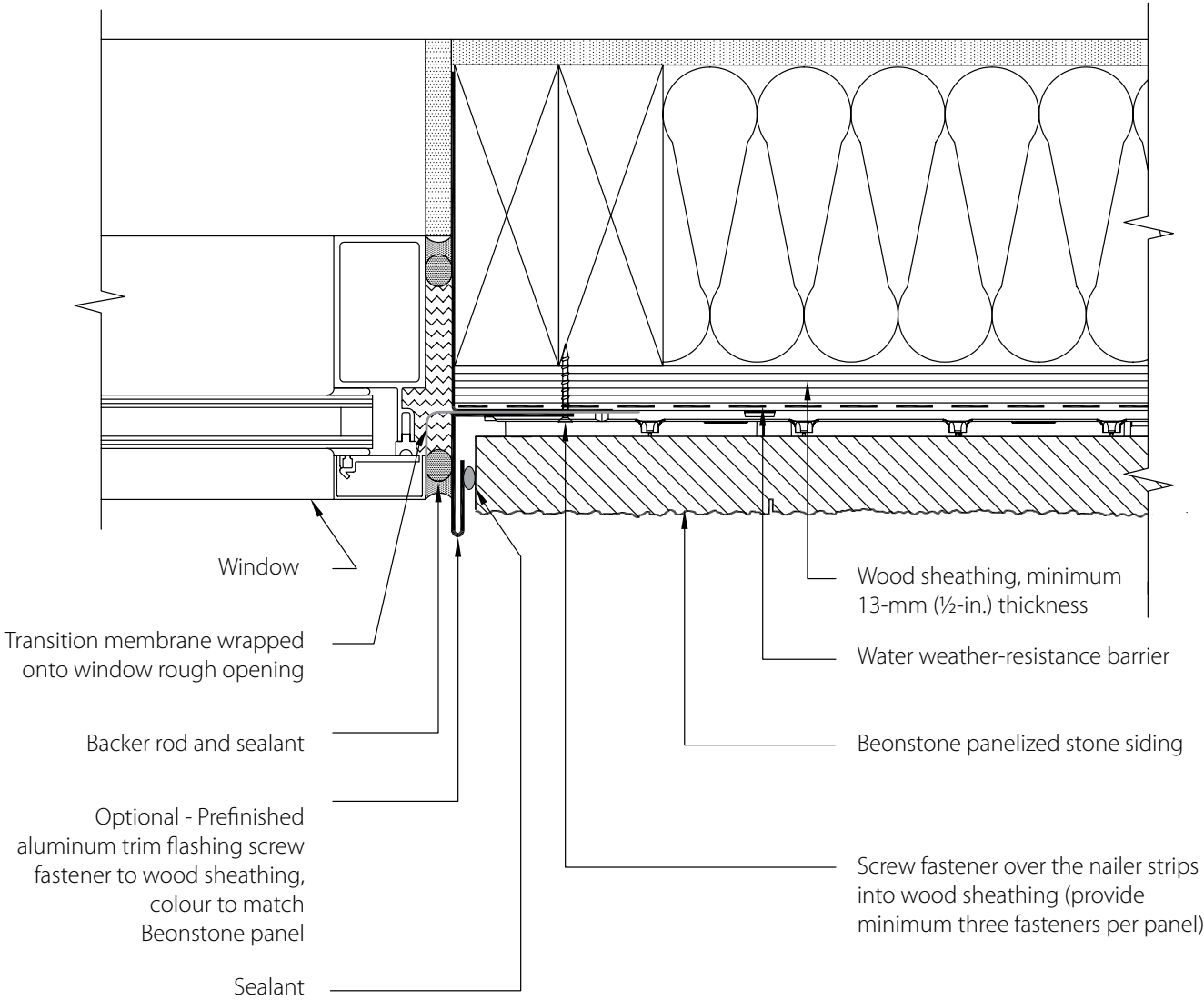

DISCLAIMER: BEONSTONE HAS PRODUCED THIS DETAIL AS AN ARCHITECTURAL GUIDE FOR THE SELECTION OF BEONSTONE PRODUCTS AND SYSTEMS. IT MUST BE MODIFIED AND ADAPTED FOR USE IN SPECIFIC PROJECTS, IN PARTICULAR WHERE GOVERNING CODES AND STANDARDS MAY HAVE ADDITIONAL REQUIREMENTS. BEONSTONE IS NOT LIABLE FOR DESIGN AND WORKMANSHIP ASSOCIATED WITH THE USE OF THIS DETAIL. PLEASE REFER TO BEONSTONE.COM FOR LATEST REVISIONS.

WOOD STUDS WITH WOOD SHEATHING (FOR LOW RISE RESIDENTIAL CONSTRUCTION)
SECTION DETAIL – WINDOW JAMB



Note: screw fasteners are to be minimum #10 x 25 mm (1 in.), corrosion-resistant type unless otherwise noted.

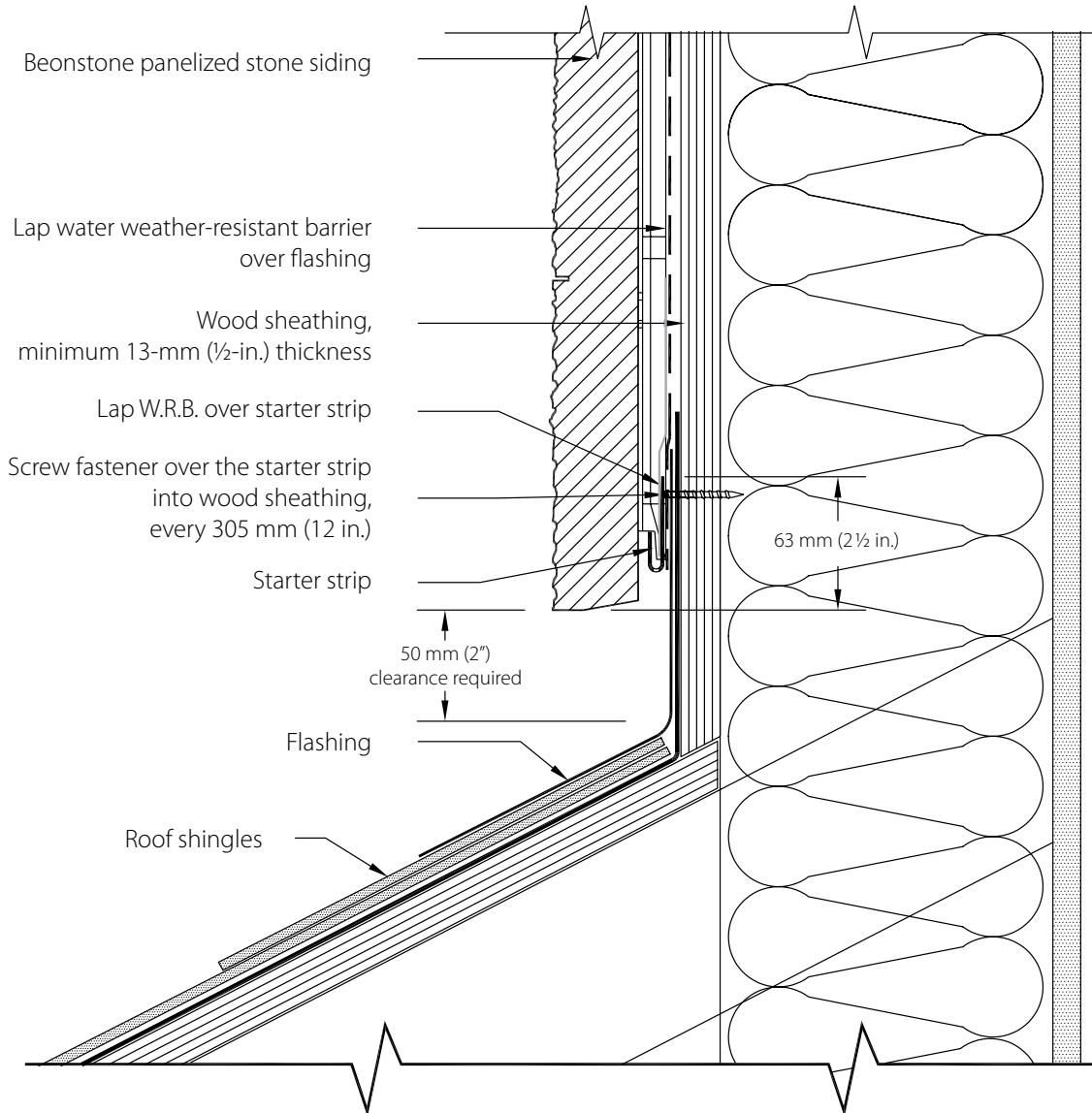

DISCLAIMER: BEONSTONE HAS PRODUCED THIS DETAIL AS AN ARCHITECTURAL GUIDE FOR THE SELECTION OF BEONSTONE PRODUCTS AND SYSTEMS. IT MUST BE MODIFIED AND ADAPTED FOR USE IN SPECIFIC PROJECTS, IN PARTICULAR WHERE GOVERNING CODES AND STANDARDS MAY HAVE ADDITIONAL REQUIREMENTS. BEONSTONE IS NOT LIABLE FOR DESIGN AND WORKMANSHIP ASSOCIATED WITH THE USE OF THIS DETAIL. PLEASE REFER TO BEONSTONE.COM FOR LATEST REVISIONS.

WOOD STUDS WITH WOOD SHEATHING (FOR LOW RISE RESIDENTIAL CONSTRUCTION)
SECTION DETAIL – TERMINATION AT SLOPE ROOF

be on
stone

Note: screw fasteners are to be minimum #10 x 25 mm (1 in.), corrosion-resistant type unless otherwise noted.

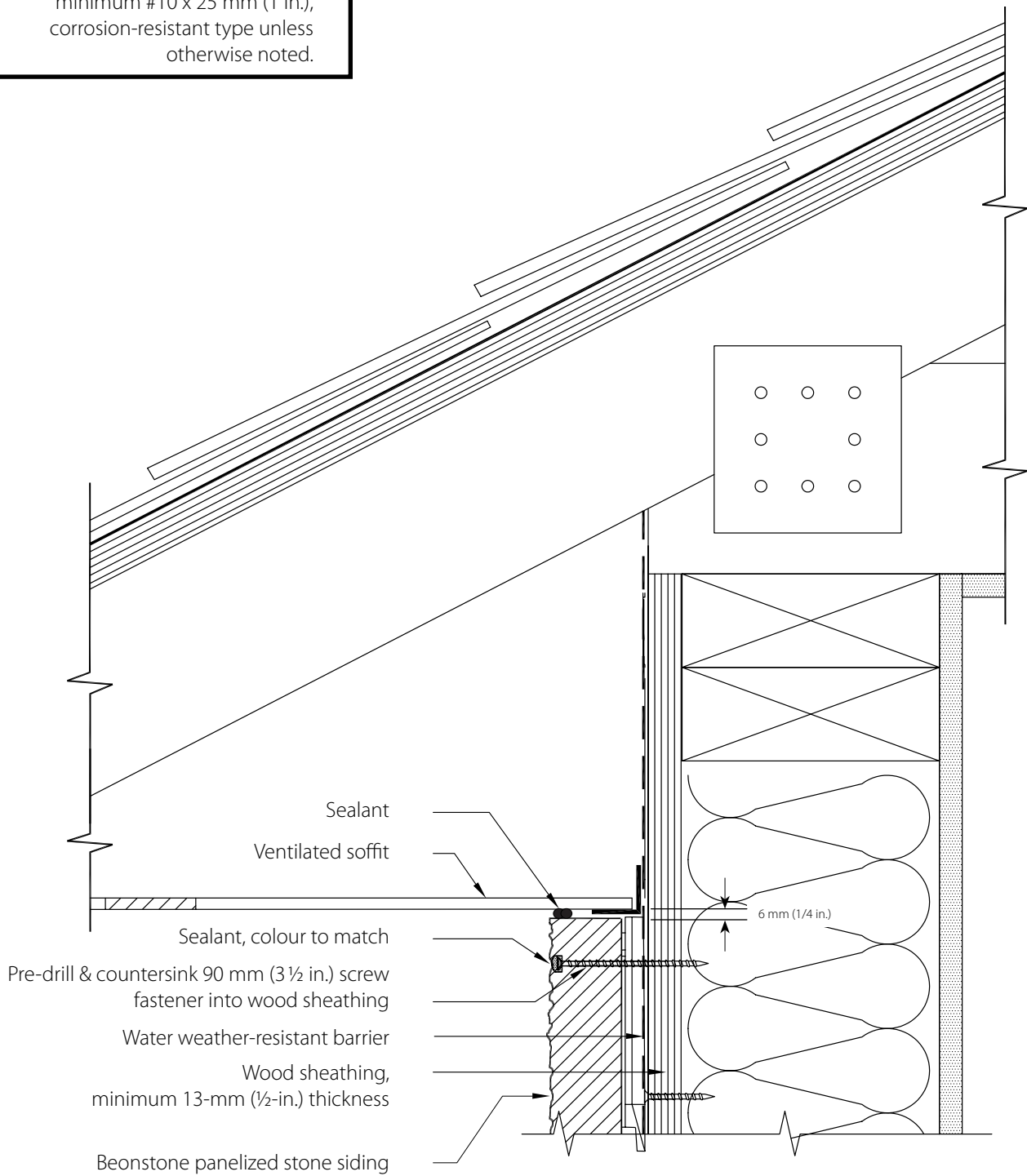

DISCLAIMER: BEONSTONE HAS PRODUCED THIS DETAIL AS AN ARCHITECTURAL GUIDE FOR THE SELECTION OF BEONSTONE PRODUCTS AND SYSTEMS. IT MUST BE MODIFIED AND ADAPTED FOR USE IN SPECIFIC PROJECTS, IN PARTICULAR WHERE GOVERNING CODES AND STANDARDS MAY HAVE ADDITIONAL REQUIREMENTS. BEONSTONE IS NOT LIABLE FOR DESIGN AND WORKMANSHIP ASSOCIATED WITH THE USE OF THIS DETAIL. PLEASE REFER TO BEONSTONE.COM FOR LATEST REVISIONS.

WOOD STUDS WITH WOOD SHEATHING (FOR LOW RISE RESIDENTIAL CONSTRUCTION)
SECTION DETAIL – TERMINATION AT SOFFIT

be on
 stone

Note: screw fasteners are to be minimum #10 x 25 mm (1 in.), corrosion-resistant type unless otherwise noted.

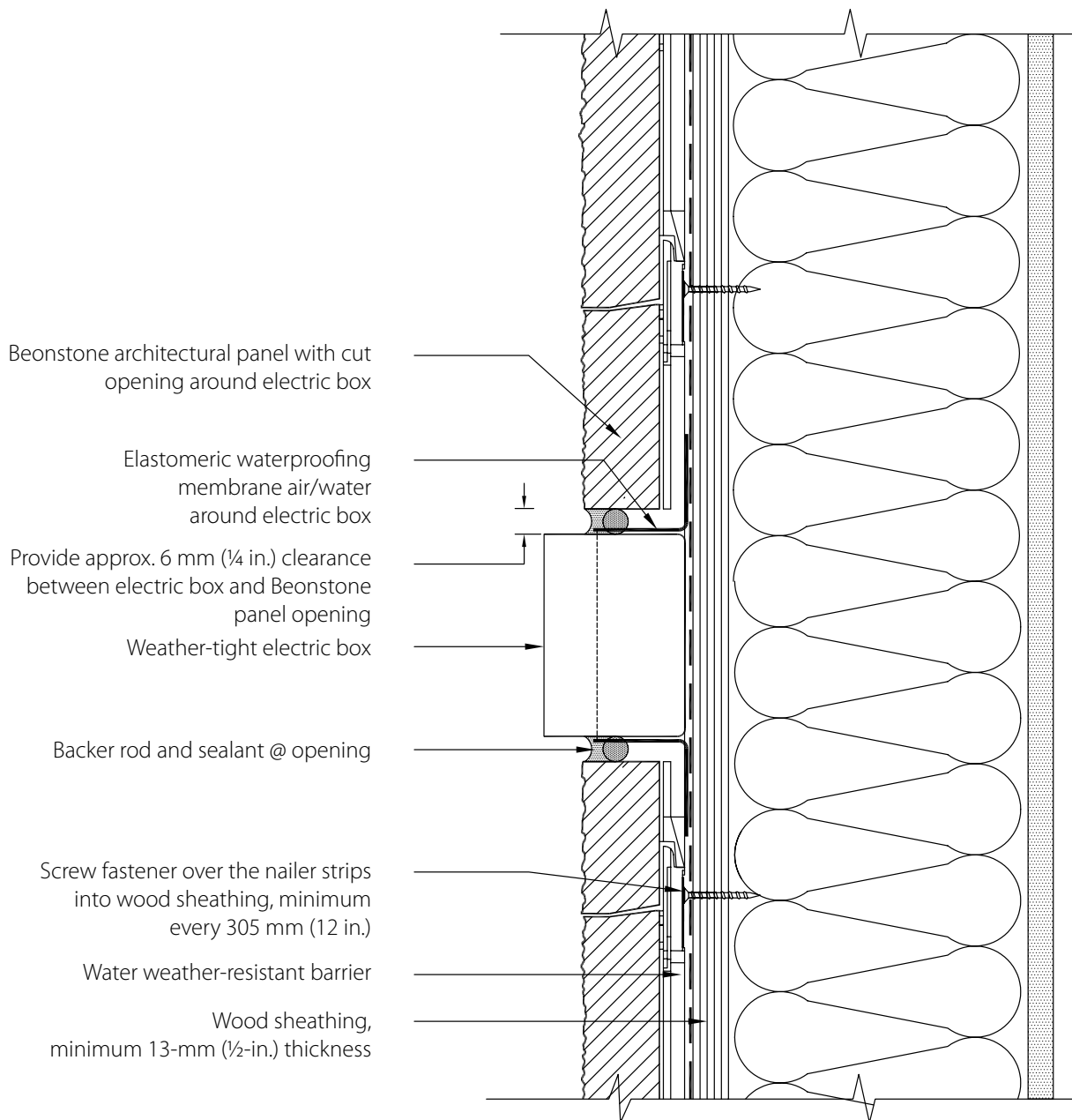

DISCLAIMER: BEONSTONE HAS PRODUCED THIS DETAIL AS AN ARCHITECTURAL GUIDE FOR THE SELECTION OF BEONSTONE PRODUCTS AND SYSTEMS. IT MUST BE MODIFIED AND ADAPTED FOR USE IN SPECIFIC PROJECTS, IN PARTICULAR WHERE GOVERNING CODES AND STANDARDS MAY HAVE ADDITIONAL REQUIREMENTS. BEONSTONE IS NOT LIABLE FOR DESIGN AND WORKMANSHIP ASSOCIATED WITH THE USE OF THIS DETAIL. PLEASE REFER TO BEONSTONE.COM FOR LATEST REVISIONS.

WOOD STUDS WITH WOOD SHEATHING (FOR LOW RISE RESIDENTIAL CONSTRUCTION)
SECTION DETAIL – EXTERIOR ELECTRIC BOX PENETRATION

be on
stone

THE EASIEST STONE TO INSTALL

STACK and FASTEN



TECHNICAL GUIDE
BEONSTONE PANELIZED STONE SIDING

be on stone

beonstone.com

PATENTED SYSTEM

ECH19-703